



# LFV230-XXSNBTPM0100

LFV200

LEVEL SENSORS

**SICK**  
Sensor Intelligence.



### Ordering information

Type	part no.
LFV230-XXSNBTPM0100	6070236

Other models and accessories → [www.sick.com/LFV200](http://www.sick.com/LFV200)

Illustration may differ



### Detailed technical data

#### Features

<b>Medium</b>	Fluids
<b>Measurement</b>	Switch
<b>Probe type</b>	Tuning fork
<b>Probe length</b>	100 mm
<b>Process pressure</b>	-1 bar ... 64 bar
<b>Process temperature</b>	-40 °C ... +100 °C
<b>Fill material density</b>	0.7 g/cm <sup>3</sup> ... 2.5 g/cm <sup>3</sup>

#### Performance

<b>Accuracy of sensor element</b>	± 2 mm
<b>Reproducibility</b>	≤ 1 mm
<b>Viscosity</b>	0.1 mPas ... 10,000 mPas
<b>Resolution</b>	≤ 1 mm
<b>Response time</b>	500 ms
<b>MTBF</b>	1,25*10 <sup>7</sup> h

#### Electronics

<b>Communication interface</b>	-
<b>Supply voltage</b>	9.6 V DC ... 35 V DC
<b>Residual ripple</b>	≤ 5 V <sub>pp</sub>
<b>Power consumption</b>	≤ 10 mA
<b>Initialization time</b>	< 2 s
<b>Connection type</b>	M12 round connector x 1, 4-pin
<b>Output signal</b>	Transistor output PNP
<b>Hysteresis</b>	2 mm
<b>Output current</b>	< 250 mA
<b>Inductive load</b>	≤ 1 H
<b>Capacitive load</b>	100 nF
<b>Enclosure rating</b>	IP67

<b>Temperature drift</b>	0.03 mm/K
--------------------------	-----------

Mechanics

<b>Wetted parts</b>	Stainless steel 1.4404 / 316L
<b>Process connection</b>	¾" NPT PN 64

Ambient data

<b>Ambient operating temperature</b>	-40 °C ... +70 °C
<b>Ambient temperature, storage</b>	-40 °C ... +80 °C

Certificates

<b>EU declaration of conformity</b>	✓
<b>UK declaration of conformity</b>	✓
<b>ACMA declaration of conformity</b>	✓
<b>China RoHS</b>	✓

Classifications

<b>ECLASS 5.0</b>	27273202
<b>ECLASS 5.1.4</b>	27273202
<b>ECLASS 6.0</b>	27273202
<b>ECLASS 6.2</b>	27273202
<b>ECLASS 7.0</b>	27273202
<b>ECLASS 8.0</b>	27273202
<b>ECLASS 8.1</b>	27273202
<b>ECLASS 9.0</b>	27273202
<b>ECLASS 10.0</b>	27273202
<b>ECLASS 11.0</b>	27273202
<b>ECLASS 12.0</b>	27273106
<b>ETIM 5.0</b>	EC002654
<b>ETIM 6.0</b>	EC002654
<b>ETIM 7.0</b>	EC002654
<b>ETIM 8.0</b>	EC002654
<b>UNSPSC 16.0901</b>	41111938

Dimensional drawing housing

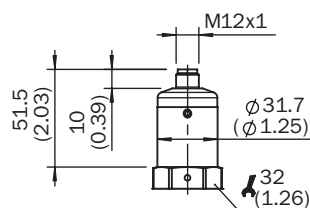

Dimensions in mm (inch)

Dimensional drawing process connection

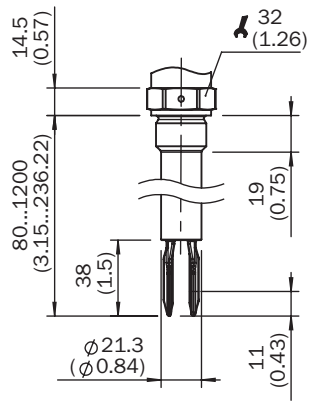





Dimensions in mm (inch)

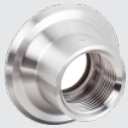
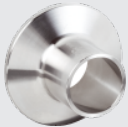

Recommended accessories

Other models and accessories → [www.sick.com/LFV200](http://www.sick.com/LFV200)

	Brief description	Type	part no.
Mounting systems			
	<ul style="list-style-type: none"> <li><b>Description:</b> Welded flange/welded connector, process connection G 1</li> <li><b>Material:</b> Stainless steel</li> <li><b>Details:</b> Stainless steel 1.4404</li> </ul>	BEF-FL-GEWG10-LFV2	4054605
	<ul style="list-style-type: none"> <li><b>Description:</b> Welded flange/welded connector, G 3/4 process connection</li> <li><b>Material:</b> Stainless steel</li> <li><b>Details:</b> Stainless steel 1.4404</li> </ul>	BEF-FL-GEWG34-LFV2	4054604
	<ul style="list-style-type: none"> <li><b>Description:</b> Welded flange/welded connector, process connection Tri-Clamp 1"</li> <li><b>Material:</b> Stainless steel</li> <li><b>Details:</b> Stainless steel 1.4404</li> </ul>	BEF-FL-TCLI10-LFV2	5321678
	<ul style="list-style-type: none"> <li><b>Description:</b> Welded flange/welded connector, process connection Tri-Clamp 2"</li> <li><b>Material:</b> Stainless steel</li> <li><b>Details:</b> Stainless steel 1.4404</li> </ul>	BEF-FL-TCLI20-LFV2	5321679
	<ul style="list-style-type: none"> <li><b>Description:</b> Welded flange/welded connector, DIN11851-1, DN25 / PN40</li> <li><b>Material:</b> Stainless steel</li> <li><b>Details:</b> Stainless steel 1.4404</li> </ul>	BEF-FL-851D25-LFV2	5321527
	<ul style="list-style-type: none"> <li><b>Description:</b> Welded flange/welded connector DIN11851-1, DN40 / PN40</li> <li><b>Material:</b> Stainless steel</li> <li><b>Details:</b> Stainless steel 1.4404</li> </ul>	BEF-FL-851D40-LFV2	5321459
	<ul style="list-style-type: none"> <li><b>Description:</b> Welded flange/welded connector DIN11851-1, DN50 / PN25</li> <li><b>Material:</b> Stainless steel</li> <li><b>Details:</b> Stainless steel 1.4404</li> </ul>	BEF-FL-851D50-LFV2	5321528

## SICK AT A GLANCE

SICK is one of the leading manufacturers of intelligent sensors and sensor solutions for industrial applications. A unique range of products and services creates the perfect basis for controlling processes securely and efficiently, protecting individuals from accidents and preventing damage to the environment.

We have extensive experience in a wide range of industries and understand their processes and requirements. With intelligent sensors, we can deliver exactly what our customers need. In application centers in Europe, Asia and North America, system solutions are tested and optimized in accordance with customer specifications. All this makes us a reliable supplier and development partner.

Comprehensive services complete our offering: SICK LifeTime Services provide support throughout the machine life cycle and ensure safety and productivity.

For us, that is “Sensor Intelligence.”

### WORLDWIDE PRESENCE:

Contacts and other locations – [www.sick.com](http://www.sick.com)

SpareCruX