



# GLL170-N333

GLL170

FIBER-OPTIC SENSORS

**SICK**  
Sensor Intelligence.



Illustration may differ



### Ordering information

Type	part no.
GLL170-N333	6063339

Other models and accessories → [www.sick.com/GLL170](http://www.sick.com/GLL170)

### Detailed technical data

#### Features

<b>Device type</b>	Fiber-optic amplifier
<b>Device type detail</b>	Stand-alone
<b>Functional principle detail</b>	Depending on the optical fiber cable used
<b>Sensing range max.</b>	Depending on the optical fiber cable used
<b>Emitted beam</b>	
Light source	LED <sup>1)</sup>
Type of light	Visible red light
<b>Key LED figures</b>	
Normative reference	EN 62471:2008-09   IEC 62471:2006, modified
LED risk group marking	Free group
Wave length	632 nm
Average service life	100,000 h at T <sub>a</sub> = +25 °C
<b>Adjustment</b>	
Potentiometer	For setting the sensing range/for setting the switching mode/for adjusting the switch-off delay
<b>Display</b>	
LED green	Operating indicator Static on: power on Dimmed in the range +/- 10 % of the switching threshold
LED yellow	Status of digital output Permanently on: Switching output active Permanently off: Digital output not active

<sup>1)</sup> Average service life: 100,000 h at T<sub>U</sub> = +25 °C.

## Safety-related parameters

<b>MTF<sub>D</sub></b>	760 years
<b>DC<sub>avg</sub></b>	0 %
<b>T<sub>M</sub> (mission time)</b>	20 years

## Electronics

<b>Supply voltage U<sub>B</sub></b>	10 V DC ... 30 V DC <sup>1)</sup>
<b>Ripple</b>	≤ 10 % <sup>2)</sup>
<b>Current consumption</b>	≤ 30 mA <sup>3)</sup>
<b>Protection class</b>	III
<b>Digital output</b>	
Number	1
Type	NPN <sup>4)</sup>
Switching mode	Light/dark switching
Signal voltage PNP HIGH/LOW	Approx. U <sub>B</sub> -1.5 V / 0 V
Signal voltage NPN HIGH/LOW	Approx. U <sub>B</sub> / < 1.5 V
Output current I <sub>max.</sub>	≤ 100 mA
Circuit protection outputs	Reverse polarity protected Overcurrent protected Short-circuit protected
Response time	≤ 250 μs
Switching frequency	2 kHz
Time functions	Without time delay, off delay
Delay time	Selectable via rotary switch, 0 ms ... 40 ms
<b>Pin/Wire assignment</b>	
Function of pin 4/black (BK)	Digital output, received light → Output Q1 HIGH
Function of pin 4/black (BK) – detail	The pin 4 function of the sensor can be configured

<sup>1)</sup> Limit values.

<sup>2)</sup> May not fall below or exceed U<sub>y</sub> tolerances.

<sup>3)</sup> Without load.

<sup>4)</sup> Selectable via rotary switch.

## Mechanics

<b>Housing</b>	Rectangular
<b>Dimensions (W x H x D)</b>	10 mm x 31.7 mm x 72.5 mm
<b>Connection</b>	Connector M8, 3-pin
<b>Connection detail</b>	
Conductor size	0.2 mm <sup>2</sup>
Cable diameter	Ø 3.8 mm
<b>Material</b>	
Housing	Plastic, PC/POM
Cable	Plastic, PVC
<b>Weight</b>	19 g

<b>Maximum tightening torque of the fixing screws</b>	0.5 Nm
---	--------

### Ambient data

<b>Enclosure rating</b>	IP66 (EN 60529)
<b>Ambient operating temperature</b>	-25 °C ... +55 °C
<b>Ambient temperature, storage</b>	-40 °C ... +70 °C
<b>Typ. Ambient light immunity</b>	Artificial light: ≤ 5,000 lx Sunlight: ≤ 60,000 lx
<b>Shock resistance</b>	50 g, 11 ms (3 positive and 3 negative shocks along X, Y, Z axes, 18 total shocks (EN60068-2-27))
<b>Vibration resistance</b>	10 Hz ... 55 Hz (Amplitude 1 mm, 3 x 30 min (EN60068-2-6))
<b>Air humidity</b>	35 % ... 95 %, relative humidity (no condensation)
<b>Electromagnetic compatibility (EMC)</b>	EN 60947-5-2
<b>UL File No.</b>	NRKH2.E300503 & NRKH8.E300503
<b>RoHS certificate</b>	✓

### Smart Task

<b>Timer function</b>	Deactivated Switch-on delay Off delay Impulse (one shot)
-----------------------	---

### Certificates

<b>EU declaration of conformity</b>	✓
<b>UK declaration of conformity</b>	✓
<b>ACMA declaration of conformity</b>	✓
<b>Moroccan declaration of conformity</b>	✓
<b>China RoHS</b>	✓
<b>cRUus certificate</b>	✓

### Classifications

<b>ECLASS 5.0</b>	27270905
<b>ECLASS 5.1.4</b>	27270905
<b>ECLASS 6.0</b>	27270905
<b>ECLASS 6.2</b>	27270905
<b>ECLASS 7.0</b>	27270905
<b>ECLASS 8.0</b>	27270905
<b>ECLASS 8.1</b>	27270905
<b>ECLASS 9.0</b>	27270905
<b>ECLASS 10.0</b>	27270905
<b>ECLASS 11.0</b>	27270905
<b>ECLASS 12.0</b>	27270905
<b>ETIM 5.0</b>	EC002651
<b>ETIM 6.0</b>	EC002651
<b>ETIM 7.0</b>	EC002651
<b>ETIM 8.0</b>	EC002651

UNSPSC 16.0901

39121528

### Adjustments GLL170

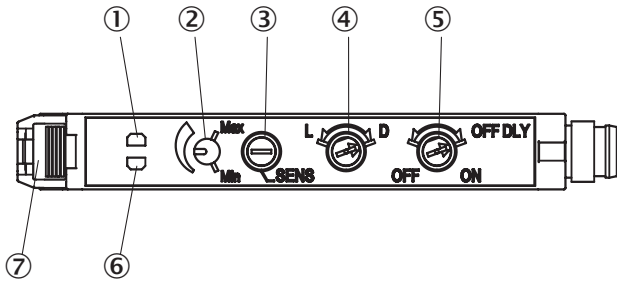

- ① LED indicator orange, lights up when switching output is active
- ② Sensitivity scale 230°
- ③ Sensitivity control: potentiometer, 8 turns
- ④ Selector switch: "L.ON" ( light switching) /"D.ON" ( dark switching)
- ⑤ OFF delay selector switch: "ON" (on)/"OFF" (off), 40 ms fixed
- ⑥ LED signal strength indicator green, lights up, when light received < 0.9 or >1.1 (switching threshold = 1)
- ⑦ Locking the fiber-optic cables

### Connection diagram Cd-045

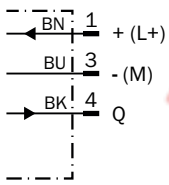

SpareCruX

### Dimensional drawing

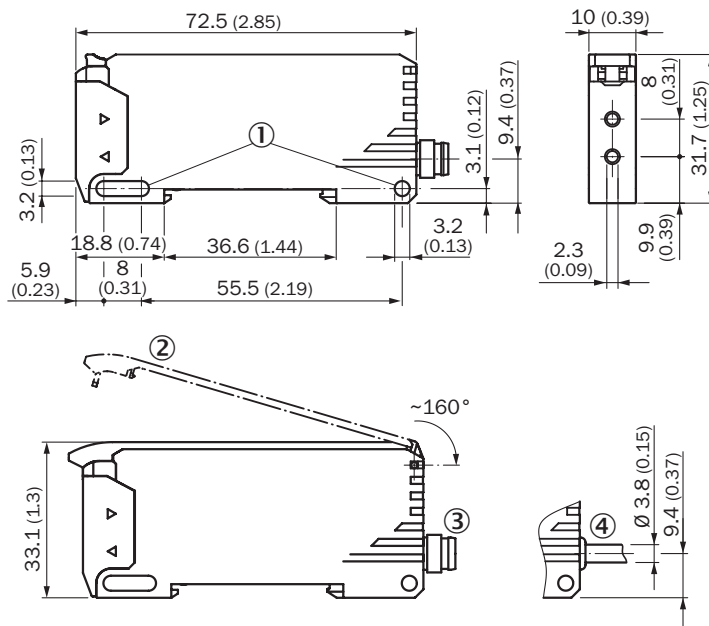



Dimensions in mm (inch)

- ① Mounting holes
- ② protective hood (optional), opens approx. 160°
- ③ Connector M8
- ④ cable





# SpareCruX

### Recommended accessories

Other models and accessories → [www.sick.com/GLL170](http://www.sick.com/GLL170)



	Brief description	Type	part no.
<b>device protection and care</b>			
	<ul style="list-style-type: none"> <li><b>Description:</b> Protective Hood for GLL170, opens approx. 160°</li> <li><b>Usable for:</b> Fiber-optic sensors</li> </ul>	BF-GLL170	5336263
	<ul style="list-style-type: none"> <li><b>Description:</b> Protective Hood for WLL80, opens approx. 180°</li> <li><b>Usable for:</b> Fiber-optic sensors</li> </ul>	BF-WLL80	5344219
<b>Mounting systems</b>			
	<ul style="list-style-type: none"> <li><b>Description:</b> Mounting bracket</li> <li><b>Material:</b> Steel</li> <li><b>Details:</b> Steel, zinc coated</li> <li><b>Items supplied:</b> Without mounting hardware</li> <li><b>Usable for:</b> Fiber-optic sensors</li> <li><b>Suitable for:</b> WLL180T, GLL170(T)</li> </ul>	BEF-WLL180	5325812

	Brief description	Type	part no.
fiber-optic sensors			
	<ul style="list-style-type: none"> <li>• <b>For fiber optic amplifiers:</b> GLL70, WLL80, WLL180, GLL170(T), WLL24 Ex, KTL180</li> <li>• <b>Functional principle:</b> Proximity system</li> <li>• <b>Fiber length:</b> 2,000 mm</li> <li>• <b>Thread diameter (housing):</b> M6</li> <li>• <b>Fiber material:</b> Plastic</li> <li>• <b>Jacket material:</b> Plastic</li> <li>• <b>Fiber head material:</b> Stainless steel</li> <li>• <b>Included with delivery:</b> Mounting, 2 x M6 hexagon nut, 2 x washer, FC fiber cutter (5304141)</li> </ul>	LL3-DB01	5308074
	<ul style="list-style-type: none"> <li>• <b>For fiber optic amplifiers:</b> GLL70, WLL80, WLL180, GLL170(T)</li> <li>• <b>Functional principle:</b> Proximity system</li> <li>• <b>Fiber length:</b> 2,000 mm</li> <li>• <b>Thread diameter (housing):</b> M3</li> <li>• <b>Fiber material:</b> Plastic</li> <li>• <b>Jacket material:</b> Plastic</li> <li>• <b>Fiber head material:</b> Stainless steel</li> <li>• <b>Included with delivery:</b> Mounting, 2 x M3 hexagon nut, 2 x washer, adapter sleeves, BF-WLL160-13 (1.3 mm) adapter sleeves, FC fiber cutter (5304141)</li> </ul>	LL3-DT01	5308076
	<ul style="list-style-type: none"> <li>• <b>For fiber optic amplifiers:</b> GLL70, WLL80, WLL180, GLL170(T), WLL24 Ex</li> <li>• <b>Functional principle:</b> Proximity system</li> <li>• <b>Fiber length:</b> 2,000 mm</li> <li>• <b>Thread diameter (housing):</b> M6</li> <li>• <b>Fiber material:</b> Plastic</li> <li>• <b>Jacket material:</b> Plastic</li> <li>• <b>Fiber head material:</b> Stainless steel</li> <li>• <b>Included with delivery:</b> Mounting, 2 x M6 hexagon nut, 2 x washer, FC fiber cutter (5304141)</li> </ul>	LL3-DB02	5308083
	<ul style="list-style-type: none"> <li>• <b>For fiber optic amplifiers:</b> GLL70, WLL80, WLL180, GLL170(T), WLL24 Ex</li> <li>• <b>Functional principle:</b> Through-beam system</li> <li>• <b>Fiber length:</b> 2,000 mm</li> <li>• <b>Thread diameter (housing):</b> M4</li> <li>• <b>Fiber material:</b> Plastic</li> <li>• <b>Jacket material:</b> Plastic</li> <li>• <b>Fiber head material:</b> Stainless steel</li> <li>• <b>Included with delivery:</b> Mounting, 4 x M4 hexagon nut, 4 x washer, FC fiber cutter (5304141)</li> </ul>	LL3-TB01	5308050
	<ul style="list-style-type: none"> <li>• <b>For fiber optic amplifiers:</b> GLL70, WLL80, WLL180, GLL170(T), WLL24 Ex</li> <li>• <b>Functional principle:</b> Proximity system</li> <li>• <b>Fiber length:</b> 2,000 mm</li> <li>• <b>Thread diameter (housing):</b> M6</li> <li>• <b>Fiber material:</b> Plastic</li> <li>• <b>Jacket material:</b> Plastic</li> <li>• <b>Fiber head material:</b> Plastic</li> <li>• <b>Included with delivery:</b> Mounting, 1 x M6 hexagon nut, FC fiber cutter (5304141)</li> </ul>	LL3-DV05	5322549
	<ul style="list-style-type: none"> <li>• <b>For fiber optic amplifiers:</b> GLL70, WLL80, WLL180, GLL170(T), WLL24 Ex</li> <li>• <b>Functional principle:</b> Through-beam system</li> <li>• <b>Fiber length:</b> 2,000 mm</li> <li>• <b>Thread diameter (housing):</b> M4</li> <li>• <b>Fiber material:</b> Plastic</li> <li>• <b>Jacket material:</b> Plastic</li> <li>• <b>Fiber head material:</b> Plastic</li> <li>• <b>Included with delivery:</b> Mounting, 2 x M4 hexagon nut, FC fiber cutter (5304141)</li> </ul>	LL3-TV05	5322546
	<ul style="list-style-type: none"> <li>• <b>For fiber optic amplifiers:</b> GLL70, WLL80, WLL180, GLL170(T), WLL24 Ex</li> <li>• <b>Functional principle:</b> Through-beam system</li> <li>• <b>Fiber length:</b> 2,000 mm</li> <li>• <b>Fiber-optic head array width:</b> 40 mm</li> <li>• <b>Fiber material:</b> Plastic</li> <li>• <b>Jacket material:</b> Plastic</li> <li>• <b>Fiber head material:</b> Plastic</li> <li>• <b>Included with delivery:</b> Mounting, 4 x M3 Phillips-head screw, FC fiber cutter (5304141), protective cladding for fiber head</li> </ul>	LL3-TS40	5323971
	<ul style="list-style-type: none"> <li>• <b>For fiber optic amplifiers:</b> GLL70, WLL80, WLL180, GLL170(T), WLL24 Ex</li> <li>• <b>Functional principle:</b> Through-beam system</li> <li>• <b>Fiber length:</b> 20,000 mm</li> <li>• <b>Thread diameter (housing):</b> M12</li> <li>• <b>Fiber material:</b> Plastic</li> <li>• <b>Jacket material:</b> Plastic</li> <li>• <b>Fiber head material:</b> Stainless steel</li> <li>• <b>Included with delivery:</b> Mounting, 4 x M12 hexagon nut, FC fiber cutter (5304141), protective cladding for fiber head</li> </ul>	LL3-TX01	5324173
	<ul style="list-style-type: none"> <li>• <b>For fiber optic amplifiers:</b> GLL70, WLL80, WLL180, GLL170(T)</li> <li>• <b>Functional principle:</b> Proximity system</li> </ul>	LL3-DR11	5326000

	Brief description	Type	part no.
	<ul style="list-style-type: none"> <li>• <b>Fiber length:</b> 2,000 mm</li> <li>• <b>Smooth sleeve diameter:</b> 3 mm</li> <li>• <b>Fiber material:</b> Plastic</li> <li>• <b>Jacket material:</b> Plastic</li> <li>• <b>Fiber head material:</b> Stainless steel</li> <li>• <b>Included with delivery:</b> Adapter sleeves, 1 x BF-WLL160-10 (1.0 mm) adapter sleeve, 1 x BF-WLL160-13 (1.3 mm) adapter sleeve, FC fiber cutter (5304141)</li> </ul>		
	<ul style="list-style-type: none"> <li>• <b>For fiber optic amplifiers:</b> GLL70, WLL80, WLL180, GLL170(T), WLL24 Ex, KTL180</li> <li>• <b>Functional principle:</b> Proximity system</li> <li>• <b>Fiber length:</b> 2,000 mm</li> <li>• <b>Fiber material:</b> Plastic</li> <li>• <b>Jacket material:</b> Plastic</li> <li>• <b>Fiber head material:</b> Plastic</li> <li>• <b>Included with delivery:</b> Adapter sleeves, BF-WLL160-10 (1.0 mm) adapter sleeves, FC fiber cutter (5304141)</li> </ul>	LL3-DC38	5322472
	<ul style="list-style-type: none"> <li>• <b>For fiber optic amplifiers:</b> GLL70, WLL80, WLL180, GLL170(T)</li> <li>• <b>Functional principle:</b> Through-beam system</li> <li>• <b>Fiber length:</b> 2,000 mm</li> <li>• <b>Thread diameter (housing):</b> M4</li> <li>• <b>Fiber material:</b> Glass</li> <li>• <b>Jacket material:</b> Stainless steel</li> <li>• <b>Fiber head material:</b> Brass</li> </ul>	LL3-TH08	5325978
	<ul style="list-style-type: none"> <li>• <b>For fiber optic amplifiers:</b> GLL70, WLL80, WLL180, GLL170(T), WLL24 Ex</li> <li>• <b>Functional principle:</b> Through-beam system</li> <li>• <b>Fiber length:</b> 2,000 mm</li> <li>• <b>Smooth sleeve diameter:</b> 6 mm</li> <li>• <b>Fiber material:</b> Plastic</li> <li>• <b>Jacket material:</b> Chemical-resistant plastic</li> <li>• <b>Fiber head material:</b> Chemical-resistant plastic</li> <li>• <b>Included with delivery:</b> FC fiber cutter (5304141)</li> </ul>	LL3-TY01	5308066



	Brief description	Type	part no.
connectors and cables			
	<ul style="list-style-type: none"> <li>• <b>Connection type head A:</b> Female connector, M8, 3-pin, straight, A-coded</li> <li>• <b>Description:</b> Unshielded</li> <li>• <b>Connection systems:</b> Screw-type terminals</li> <li>• <b>Permitted cross-section:</b> 0.14 mm<sup>2</sup> ... 0.5 mm<sup>2</sup></li> </ul>	DOS-0803-G	7902077
	<ul style="list-style-type: none"> <li>• <b>Connection type head A:</b> Female connector, M8, 3-pin, angled, A-coded</li> <li>• <b>Description:</b> Unshielded</li> <li>• <b>Connection systems:</b> Solder connection</li> <li>• <b>Permitted cross-section:</b> ≤ 0.25 mm<sup>2</sup></li> </ul>	DOS-0803-W	7902078
	<ul style="list-style-type: none"> <li>• <b>Connection type head A:</b> Male connector, M8, 3-pin, straight, A-coded</li> <li>• <b>Description:</b> Unshielded</li> <li>• <b>Connection systems:</b> Screw-type terminals</li> <li>• <b>Permitted cross-section:</b> 0.14 mm<sup>2</sup> ... 0.5 mm<sup>2</sup></li> </ul>	STE-0803-G	6037322
	<ul style="list-style-type: none"> <li>• <b>Connection type head A:</b> Female connector, M8, 3-pin, straight, A-coded</li> <li>• <b>Connection type head B:</b> Flying leads</li> <li>• <b>Signal type:</b> Sensor/actuator cable</li> <li>• <b>Cable:</b> 2 m, 3-wire, PVC</li> <li>• <b>Description:</b> Sensor/actuator cable, unshielded</li> <li>• <b>Application:</b> Zones with chemicals, Uncontaminated zones</li> </ul>	YF8U13-020VA1XLEAX	2095860
	<ul style="list-style-type: none"> <li>• <b>Connection type head A:</b> Female connector, M8, 3-pin, straight, A-coded</li> <li>• <b>Connection type head B:</b> Flying leads</li> <li>• <b>Signal type:</b> Sensor/actuator cable</li> <li>• <b>Cable:</b> 5 m, 3-wire, PVC</li> <li>• <b>Description:</b> Sensor/actuator cable, unshielded</li> <li>• <b>Application:</b> Zones with chemicals, Uncontaminated zones</li> </ul>	YF8U13-050VA1XLEAX	2095884
	<ul style="list-style-type: none"> <li>• <b>Connection type head A:</b> Female connector, M8, 3-pin, straight, A-coded</li> <li>• <b>Connection type head B:</b> Flying leads</li> <li>• <b>Signal type:</b> Sensor/actuator cable</li> <li>• <b>Cable:</b> 10 m, 3-wire, PVC</li> <li>• <b>Description:</b> Sensor/actuator cable, unshielded</li> <li>• <b>Application:</b> Zones with chemicals, Uncontaminated zones</li> </ul>	YF8U13-100VA1XLEAX	2095885
	<ul style="list-style-type: none"> <li>• <b>Connection type head A:</b> Female connector, M8, 3-pin, angled, A-coded</li> <li>• <b>Connection type head B:</b> Flying leads</li> <li>• <b>Signal type:</b> Sensor/actuator cable</li> <li>• <b>Cable:</b> 2 m, 3-wire, PVC</li> <li>• <b>Description:</b> Sensor/actuator cable, unshielded</li> <li>• <b>Application:</b> Zones with chemicals, Uncontaminated zones</li> </ul>	YG8U13-020VA1XLEAX	2096165
	<ul style="list-style-type: none"> <li>• <b>Connection type head A:</b> Female connector, M8, 3-pin, angled, A-coded</li> <li>• <b>Connection type head B:</b> Flying leads</li> <li>• <b>Signal type:</b> Sensor/actuator cable</li> <li>• <b>Cable:</b> 5 m, 3-wire, PVC</li> <li>• <b>Description:</b> Sensor/actuator cable, unshielded</li> <li>• <b>Application:</b> Zones with chemicals, Uncontaminated zones</li> </ul>	YG8U13-050VA1XLEAX	2096166
	<ul style="list-style-type: none"> <li>• <b>Connection type head A:</b> Female connector, M8, 3-pin, angled, A-coded</li> <li>• <b>Connection type head B:</b> Flying leads</li> <li>• <b>Signal type:</b> Sensor/actuator cable</li> <li>• <b>Cable:</b> 10 m, 3-wire, PVC</li> <li>• <b>Description:</b> Sensor/actuator cable, unshielded</li> <li>• <b>Application:</b> Zones with chemicals, Uncontaminated zones</li> </ul>	YG8U13-100VA1XLEAX	2096209
	<ul style="list-style-type: none"> <li>• <b>Connection type head A:</b> Female connector, M8, 3-pin, straight, A-coded</li> <li>• <b>Connection type head B:</b> Flying leads</li> <li>• <b>Signal type:</b> Sensor/actuator cable</li> <li>• <b>Cable:</b> 0.6 m, 3-wire, PVC</li> <li>• <b>Description:</b> Sensor/actuator cable, unshielded</li> <li>• <b>Application:</b> Zones with chemicals, Uncontaminated zones</li> </ul>	YF8U13-C60VA1XLEAX	2146368
	<ul style="list-style-type: none"> <li>• <b>Connection type head A:</b> Female connector, M8, 3-pin, angled, A-coded</li> <li>• <b>Connection type head B:</b> Flying leads</li> <li>• <b>Signal type:</b> Sensor/actuator cable</li> <li>• <b>Cable:</b> 1 m, 3-wire, PVC</li> <li>• <b>Description:</b> Sensor/actuator cable, unshielded</li> </ul>	YG8U13-010VA1XLEAX	2146371

	Brief description	Type	part no.
	<ul style="list-style-type: none"> <li>• <b>Application:</b> Zones with chemicals, Uncontaminated zones</li> <li>• <b>Connection type head A:</b> Female connector, M8, 3-pin, angled, A-coded</li> <li>• <b>Connection type head B:</b> Flying leads</li> <li>• <b>Signal type:</b> Sensor/actuator cable</li> <li>• <b>Cable:</b> 3 m, 3-wire, PVC</li> <li>• <b>Description:</b> Sensor/actuator cable, unshielded</li> <li>• <b>Application:</b> Zones with chemicals, Uncontaminated zones</li> </ul>	YG8U13-030VA1XLEAX	2146372
	<ul style="list-style-type: none"> <li>• <b>Connection type head A:</b> Female connector, M8, 3-pin, angled, A-coded</li> <li>• <b>Connection type head B:</b> Flying leads</li> <li>• <b>Signal type:</b> Sensor/actuator cable</li> <li>• <b>Cable:</b> 0.6 m, 3-wire, PVC</li> <li>• <b>Description:</b> Sensor/actuator cable, unshielded</li> <li>• <b>Application:</b> Zones with chemicals, Uncontaminated zones</li> </ul>	YG8U13-C60VA1XLEAX	2146370



## SICK AT A GLANCE

SICK is one of the leading manufacturers of intelligent sensors and sensor solutions for industrial applications. A unique range of products and services creates the perfect basis for controlling processes securely and efficiently, protecting individuals from accidents and preventing damage to the environment.

We have extensive experience in a wide range of industries and understand their processes and requirements. With intelligent sensors, we can deliver exactly what our customers need. In application centers in Europe, Asia and North America, system solutions are tested and optimized in accordance with customer specifications. All this makes us a reliable supplier and development partner.

Comprehensive services complete our offering: SICK LifeTime Services provide support throughout the machine life cycle and ensure safety and productivity.

For us, that is “Sensor Intelligence.”

### WORLDWIDE PRESENCE:

Contacts and other locations – [www.sick.com](http://www.sick.com)

SpareCruX