



UC30-214164

UC30

ULTRASONIC DISTANCE SENSORS

**SICK**  
Sensor Intelligence.



### Ordering information

Type	part no.
UC30-214164	6054713

Other models and accessories → [www.sick.com/UC30](http://www.sick.com/UC30)



### Detailed technical data

#### Features

<b>Operating range, limiting range</b>	350 mm ... 3,400 mm, 5,000 mm				
<b>Resolution</b>	≥ 0.18 mm				
<b>Repeatability</b>	± 0.15 % <sup>1)</sup>				
<b>Measurement accuracy</b>	± 1 % <sup>2) 3)</sup>				
<b>Temperature compensation</b>	✓				
<b>Response time</b>	180 ms				
<b>Switching frequency</b>	4 Hz				
<b>Output time</b>	43 ms				
<b>Ultrasonic frequency (typical)</b>	120 kHz				
<b>Detection area (typical)</b>	See diagrams				
<b>Additional function</b>	Adjustable operating modes: Switching point (DtO) / Switching window/Background (ObSB), teach-in of digital output, set levels of digital outputs, invertable digital output, set on delay digital output, synchronization of up to 50 sensors, multiplexing: no cross talk of up to 50 sensors, adjustable measurement filters: Measured value filters/Filter strength/Foreground suppression/Detection area/Sensitivity and sound beam, reset to factory default				
<b>Safety-related parameters</b>	<table border="0"> <tr> <td>MTTF<sub>D</sub></td> <td>101 years</td> </tr> <tr> <td>DC<sub>avg</sub></td> <td>0%</td> </tr> </table>	MTTF <sub>D</sub>	101 years	DC <sub>avg</sub>	0%
MTTF <sub>D</sub>	101 years				
DC <sub>avg</sub>	0%				

<sup>1)</sup> In relation to the current measured value, minimum value ≥ resolution.

<sup>2)</sup> Referring to current measurement value.

<sup>3)</sup> Temperature compensation can be switched off, without temperature compensation: 0.17 % / K.

#### Interfaces

Digital output	Number	Type
	2 <sup>1)</sup>	NPN

<sup>1)</sup> NPN: HIGH = ≤ 2 V / LOW = U<sub>v</sub>.

Maximum output current $I_A$	$\leq 200$ mA
<b>Multifunctional input (MF)</b>	1 x MF
<b>Hysteresis</b>	50 mm

<sup>1)</sup> NPN: HIGH =  $\leq 2$  V / LOW =  $U_V$ .

## Electronics

<b>Supply voltage <math>U_B</math></b>	DC 9 V ... 30 V <sup>1)</sup>
<b>Power consumption</b>	$\leq 1.2$ W <sup>2)</sup>
<b>Initialization time</b>	< 380 ms
<b>Display</b>	2 x LED
<b>Enclosure rating</b>	IP65 / IP67
<b>Protection class</b>	III

<sup>1)</sup> Limit values, reverse-polarity protected Operation in short-circuit protected network: max. 8 A, class 2.

<sup>2)</sup> Without load.

## Mechanics

<b>Dimensions (W x H x D)</b>	62 mm x 62 mm x 33.2 mm <sup>1)</sup> 62 mm x 62 mm x 32.7 mm <sup>2)</sup>
<b>Design</b>	Rectangular
<b>Sending axis</b>	Straight
<b>Housing material</b>	Plastic (PBT/PET, ultrasonic transducer: polyurethane foam, glass epoxy resin)
<b>Weight</b>	180 g
<b>Connection type</b>	Male connector, M12, 5-pin

<sup>1)</sup> Serial number S/N 2405xxxx or higher.

<sup>2)</sup> Up to serial number S/N 2404xxxx.

## Ambient data

<b>Ambient temperature, operation</b>	-25 °C ... +70 °C
<b>Ambient temperature, storage</b>	-40 °C ... +85 °C

## Certificates

<b>EU declaration of conformity</b>	✓
<b>UK declaration of conformity</b>	✓
<b>ACMA declaration of conformity</b>	✓
<b>Moroccan declaration of conformity</b>	✓
<b>China RoHS</b>	✓
<b>cULus certificate</b>	✓

## Classifications

<b>ECLASS 5.0</b>	27270804
<b>ECLASS 5.1.4</b>	27270804
<b>ECLASS 6.0</b>	27270804
<b>ECLASS 6.2</b>	27270804
<b>ECLASS 7.0</b>	27270804

<b>ECLASS 8.0</b>	27270804
<b>ECLASS 8.1</b>	27270804
<b>ECLASS 9.0</b>	27270804
<b>ECLASS 10.0</b>	27270804
<b>ECLASS 11.0</b>	27270804
<b>ECLASS 12.0</b>	27272806
<b>ETIM 5.0</b>	EC001846
<b>ETIM 6.0</b>	EC001846
<b>ETIM 7.0</b>	EC001846
<b>ETIM 8.0</b>	EC001846
<b>UNSPSC 16.0901</b>	41111960

Dimensional drawing | serial number S/N 240<b>5</b>xxxx or higher

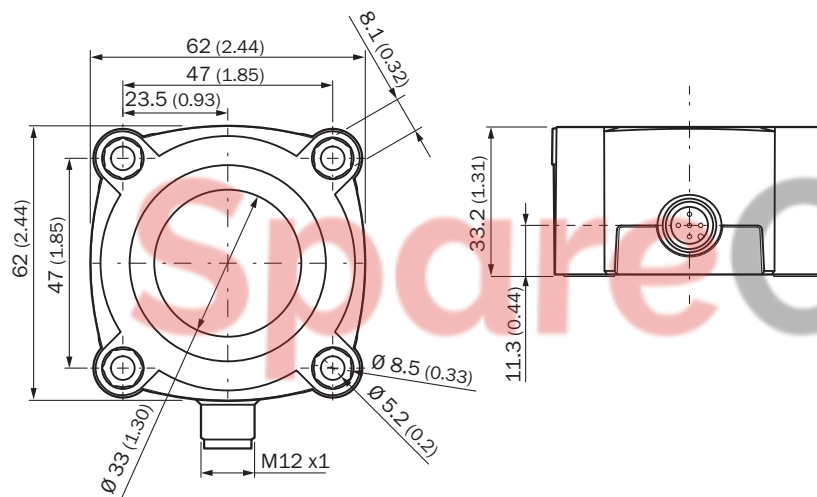

Dimensions in mm (inch)

**Note:** The position of the screw head in the hole is now 12 mm deeper, please check the screw length.

### Connection type

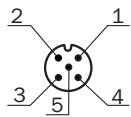

### Connection diagram

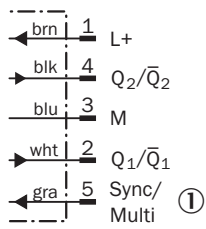

① Synchronization and multiplex mode, Connect+ communication

Adjustment possible | serial number S/N 240<b>5</b>xxxx or higher

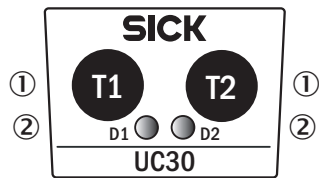

① Control elements  
② LED status indicator

### Detection area

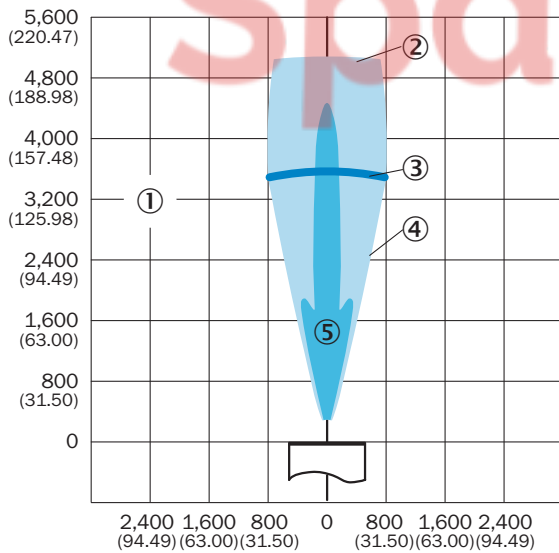





dimensions in mm (inch)

- ① Detection range dependent on reflection properties, size, and alignment of the object
- ② Limiting range
- ③ operating range
- ④ example object: aligned plate 500 mm x 500 mm
- ⑤ example object: pipe with 27 mm diameter

Recommended accessories

Other models and accessories → [www.sick.com/UC30](http://www.sick.com/UC30)

	Brief description	Type	part no.
programming devices			
	<ul style="list-style-type: none"> <li><b>Product segment:</b> Integration modules and adapters</li> <li><b>Product family:</b> Cloning modules</li> <li><b>Description:</b> Tool for visualization, configuration and cloning, 3-digit LED display, supply voltage: DV 9 V ... 30 V</li> </ul>	Connect+ adapter (CPA)	6037782
connectors and cables			
	<ul style="list-style-type: none"> <li><b>Connection type head A:</b> Female connector, M12, 5-pin, straight, A-coded</li> <li><b>Connection type head B:</b> Flying leads</li> <li><b>Signal type:</b> Sensor/actuator cable</li> <li><b>Cable:</b> 2 m, 5-wire, PVC</li> <li><b>Description:</b> Sensor/actuator cable, unshielded</li> <li><b>Application:</b> Zones with chemicals, Uncontaminated zones</li> </ul>	YF2A15-020VB5XLEAX	2096239
	<ul style="list-style-type: none"> <li><b>Connection type head A:</b> Female connector, M12, 5-pin, straight, A-coded</li> <li><b>Connection type head B:</b> Flying leads</li> <li><b>Signal type:</b> Sensor/actuator cable</li> <li><b>Cable:</b> 0.6 m, 5-wire, PVC</li> <li><b>Description:</b> Sensor/actuator cable, unshielded</li> <li><b>Application:</b> Zones with chemicals, Uncontaminated zones</li> </ul>	YF2A15-C60VB5XLEAX	2145570
	<ul style="list-style-type: none"> <li><b>Connection type head A:</b> Female connector, M12, 5-pin, straight, A-coded</li> <li><b>Connection type head B:</b> Flying leads</li> <li><b>Signal type:</b> Sensor/actuator cable</li> <li><b>Cable:</b> 3 m, 5-wire, PVC</li> <li><b>Description:</b> Sensor/actuator cable, unshielded</li> <li><b>Application:</b> Zones with chemicals, Uncontaminated zones</li> </ul>	YF2A15-030VB5XLEAX	2145572



## SICK AT A GLANCE

SICK is one of the leading manufacturers of intelligent sensors and sensor solutions for industrial applications. A unique range of products and services creates the perfect basis for controlling processes securely and efficiently, protecting individuals from accidents and preventing damage to the environment.

We have extensive experience in a wide range of industries and understand their processes and requirements. With intelligent sensors, we can deliver exactly what our customers need. In application centers in Europe, Asia and North America, system solutions are tested and optimized in accordance with customer specifications. All this makes us a reliable supplier and development partner.

Comprehensive services complete our offering: SICK LifeTime Services provide support throughout the machine life cycle and ensure safety and productivity.

For us, that is “Sensor Intelligence.”

### WORLDWIDE PRESENCE:

Contacts and other locations – [www.sick.com](http://www.sick.com)

SpareCruX