



UC4-13345S02

UC4

ULTRASONIC DISTANCE SENSORS

SICK
Sensor Intelligence.



Ordering information

Type	part no.
UC4-13345S02	6049510

Other models and accessories → www.sick.com/UC4



Detailed technical data

Features

Operating range, limiting range	13 mm ... 150 mm, 250 mm ¹⁾
Target	Natural objects
Resolution	≥ 0.1 mm
Repeatability	± 0.15 % ²⁾
Measurement accuracy	± 1 % ³⁾
Response time	10 ms
Switching frequency	100 Hz
Output time	5 ms
Ultrasonic frequency (typical)	380 kHz
Detection area (typical)	See diagrams
Additional function	Adjustable operating modes: Switching point (Dt0) / Switching window/Background (ObSB), teach-in of digital output, invertable digital output, teach-in button(s) (can be deactivated), re-set to factory default ⁴⁾
Safety-related parameters	
	MTTF _D 101 years
	DC _{avg} 0%

¹⁾ Teach-in from 21 mm.

²⁾ In relation to the current measured value, minimum value ≥ resolution.

³⁾ Referring to current measurement value.

⁴⁾ Functions may vary depending on sensor type.

Interfaces

Digital output	
	Number 1 ¹⁾

¹⁾ NPN: HIGH = ≤ 2 V / LOW = U_v.

Type	NPN
Maximum output current I_A	≤ 200 mA
Hysteresis	2 mm

¹⁾ NPN: HIGH = ≤ 2 V / LOW = U_V .

Electronics

Supply voltage U_B	DC 15 V ... 30 V ¹⁾
Power consumption	≤ 0.9 W ²⁾
Initialization time	< 300 ms
Indication	2 x LED
Enclosure rating	IP65 / IP67
Protection class	III

¹⁾ Limit values, reverse-polarity protected, operation in short-circuit protected network: max. 8 A.

²⁾ Without load.

Mechanics

Dimensions (W x H x D)	16 mm x 40.1 mm x 16.7 mm
Design	Rectangular
Sending axis	Straight
Housing material	Plastic (ABS, ultrasonic transducer: polyurethane foam, glass epoxy resin)
Weight	10 g
Connection type	Male connector, M8, 3-pin

Ambient data

Ambient temperature, operation	-25 °C ... +70 °C ¹⁾
Ambient temperature, storage	-40 °C ... +85 °C
Temperature drift	0.17 % / K ²⁾

¹⁾ At operating temperatures of > 50 °C, the rear side of the UC4 must be installed with its surface flat against a bracket.

²⁾ Referring to current measurement value.

Certificates

EU declaration of conformity	✓
UK declaration of conformity	✓
ACMA declaration of conformity	✓
Moroccan declaration of conformity	✓
China RoHS	✓
cULus certificate	✓

Classifications

ECLASS 5.0	27270804
ECLASS 5.1.4	27270804
ECLASS 6.0	27270804
ECLASS 6.2	27270804
ECLASS 7.0	27270804

ECLASS 8.0	27270804
ECLASS 8.1	27270804
ECLASS 9.0	27270804
ECLASS 10.0	27270804
ECLASS 11.0	27270804
ECLASS 12.0	27272806
ETIM 5.0	EC001846
ETIM 6.0	EC001846
ETIM 7.0	EC001846
ETIM 8.0	EC001846
UNSPSC 16.0901	41111960

Dimensional drawing

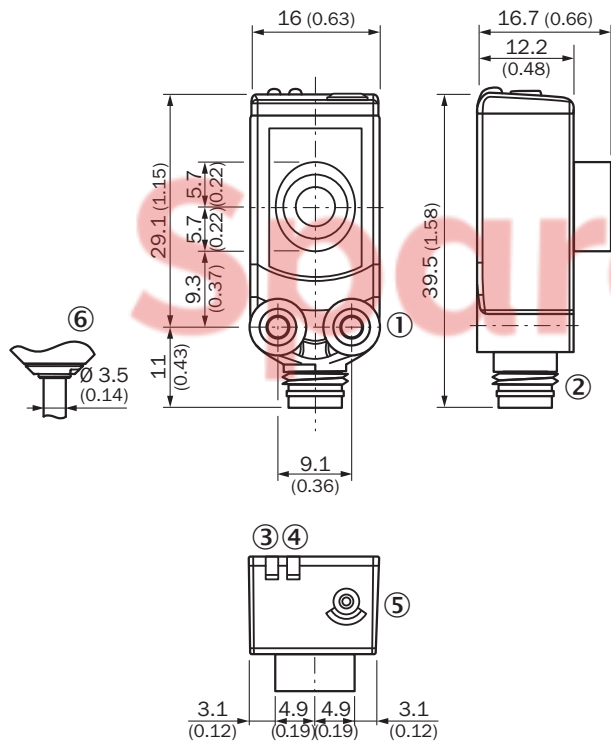

Dimensions in mm (inch)

- ① Threaded mounting hole M3
- ② Connection
- ③ status indicator digital output (orange)
- ④ Status display for supply voltage active (green)
- ⑤ Control elements

Connection type Connector M8, 3-pin

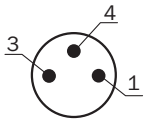

Connection diagram

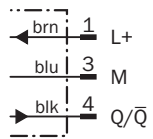

Adjustment possible

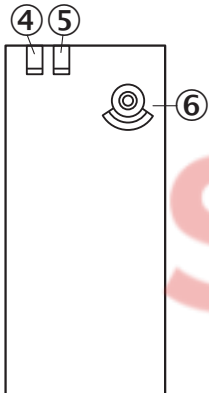

- ④ status indicator digital output (orange)
- ⑤ Status display for supply voltage active (green)
- ⑥ Control elements

SpareCruX

Detection area UC4-13

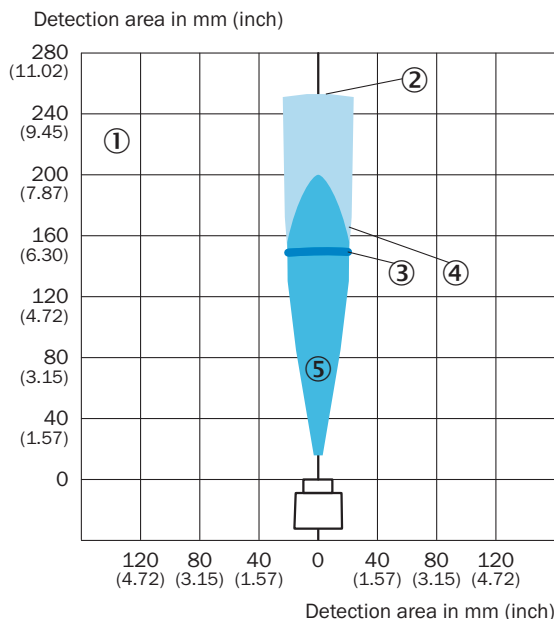





- ① Detection range dependent on reflection properties, size, and alignment of the object
- ② Limiting range
- ③ operating range
- ④ Example object: aligned plate 100 mm x 100 mm
- ⑤ Example object: cylindrical bar with a diameter of 10 mm



Recommended accessories

Other models and accessories → www.sick.com/UC4

	Brief description	Type	part no.
Mounting systems			
	<ul style="list-style-type: none"> • Description: Mounting bracket for wall mounting • Material: Stainless steel • Details: Stainless steel 1.4571 • Items supplied: Mounting hardware included • Suitable for: W4S, W4F, W4S 	BEF-W4-A	2051628
	<ul style="list-style-type: none"> • Description: Accessory for ultrasonic channeling for the product family UC4 	SonicTube UC4	5329249

	Brief description	Type	part no.
connectors and cables			
	<ul style="list-style-type: none"> • Connection type head A: Female connector, M8, 3-pin, straight, A-coded • Connection type head B: Flying leads • Signal type: Sensor/actuator cable • Cable: 2 m, 3-wire, PVC • Description: Sensor/actuator cable, unshielded • Application: Zones with chemicals, Uncontaminated zones 	YF8U13-020VA1XLEAX	2095860
	<ul style="list-style-type: none"> • Connection type head A: Female connector, M8, 3-pin, straight, A-coded • Connection type head B: Flying leads • Signal type: Sensor/actuator cable • Cable: 0.6 m, 3-wire, PVC • Description: Sensor/actuator cable, unshielded • Application: Zones with chemicals, Uncontaminated zones 	YF8U13-C60VA1XLEAX	2146368



SICK AT A GLANCE

SICK is one of the leading manufacturers of intelligent sensors and sensor solutions for industrial applications. A unique range of products and services creates the perfect basis for controlling processes securely and efficiently, protecting individuals from accidents and preventing damage to the environment.

We have extensive experience in a wide range of industries and understand their processes and requirements. With intelligent sensors, we can deliver exactly what our customers need. In application centers in Europe, Asia and North America, system solutions are tested and optimized in accordance with customer specifications. All this makes us a reliable supplier and development partner.

Comprehensive services complete our offering: SICK LifeTime Services provide support throughout the machine life cycle and ensure safety and productivity.

For us, that is “Sensor Intelligence.”

WORLDWIDE PRESENCE:

Contacts and other locations – www.sick.com

SpareCruX