

IMA30-40NE1ZC0K

IMA

INDUCTIVE PROXIMITY SENSORS

SICK
Sensor Intelligence.

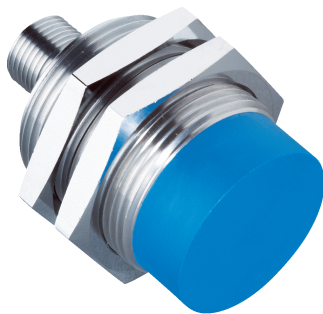

Illustration may differ



Ordering information

Type	part no.
IMA30-40NE1ZCOK	6041796

Other models and accessories → www.sick.com/IMA

Detailed technical data

Features

Housing	Metric
Thread size	M30 x 1.5
Diameter	Ø 30 mm
Sensing range S_n	0 mm ... 40 mm
Installation type	Non-flush
Connection type	Male connector M12, 4-pin
Output function	Analog
Repeatability (T_a not constant)	0.6 mm ^{1) 2) 3)}
Repeatability (T_a constant)	± 0.1 mm
Resolution	≤ 10 µm
Enclosure rating	IP67 ⁴⁾
Special features	Analog output, triple sensing range
Items supplied	Mounting nut, brass, chromium-plated (2x) Toothed washer, stainless steel (2 x)

¹⁾ As per IEC 60947-5-2.

²⁾ $U_b = DC 20 V \dots 30 V$.

³⁾ $T_A = 23 \text{ °C} \pm 5 \text{ °C}$.

⁴⁾ According to EN 60529: 2000-09.

Mechanics/electronics

Supply voltage	15 V DC ... 30 V DC
Ripple	≤ 20 % ¹⁾

¹⁾ Of V_s .

²⁾ Without load.

³⁾ At voltage output QA1.

⁴⁾ -3 dB if $S_n = 20 \text{ mm}$.

⁵⁾ QA1 loaded, QA2 unloaded.

⁶⁾ QA1 loaded, QA2 loaded: see temperature reduction.

Time delay before availability	≤ 50 ms
Temperature drift (of S_i)	≤ 10 %
No load current	≤ 12 mA ²⁾
Load current	± 10 mA ³⁾
Max. load resistance	≤ 400 Ω U _b = 15 V ≤ 1,000 Ω U _b = 30 V
Output voltage Q_{A1}	s = 0 mm: 0 V/-0 +0,4 V (23 °C) s = 20 mm: +5,2 V/ +0,4 V (23 °C) s = 40 mm: +10 V/ +0,4 V (23 °C)
Output current Q_{A2}	s = 0 mm: 4 mA/ +0,8 mA (23 °C) s = 40 mm: 20 mA/ +0,8 mA (23 °C)
Output voltage	0 V ... 10 V
Bandwidth	100 Hz ⁴⁾
Short-circuit protection	✓
Ambient operating temperature	-25 °C ... +70 °C ^{5) 6)}
Housing material	Brass, chromium-plated
Sensing face material	Plastic, PTB
Housing length	48.5 mm
Thread length	25 mm

1) Of V_S.

2) Without load.

3) At voltage output QA1.

4) -3 dB if S_n = 20 mm.

5) QA1 loaded, QA2 unloaded.

6) QA1 loaded, QA2 loaded: see temperature reduction.

SpareCruX

Safety-related parameters

MTTF_D	87 years
DC_{avg}	0%
T_M (mission time)	20 years

Reduction factors

Note	The values are reference values which may vary
Stainless steel (V2A, 304)	Approx. 0.8
Aluminum (Al)	Approx. 0.4
Copper (Cu)	Approx. 0.4
Brass (Br)	Approx. 0.5

Installation note

Remark	Associated graphic see "Installation"
A	40 mm
B	120 mm
C	30 mm
D	120 mm
E	Aluminium: 25 mm, Steel: 35 mm, Brass: 25 mm, Stainless steel: 20 mm
F	400 mm

Certificates

EU declaration of conformity	✓
UK declaration of conformity	✓
ACMA declaration of conformity	✓
Moroccan declaration of conformity	✓
China RoHS	✓

Classifications

ECLASS 5.0	27270101
ECLASS 5.1.4	27270101
ECLASS 6.0	27270101
ECLASS 6.2	27270101
ECLASS 7.0	27270101
ECLASS 8.0	27270101
ECLASS 8.1	27270101
ECLASS 9.0	27270101
ECLASS 10.0	27270101
ECLASS 11.0	27270101
ECLASS 12.0	27274001
ETIM 5.0	EC002714
ETIM 6.0	EC002714
ETIM 7.0	EC002714
ETIM 8.0	EC002714
UNSPSC 16.0901	39122230



Installation note Non-flush installation

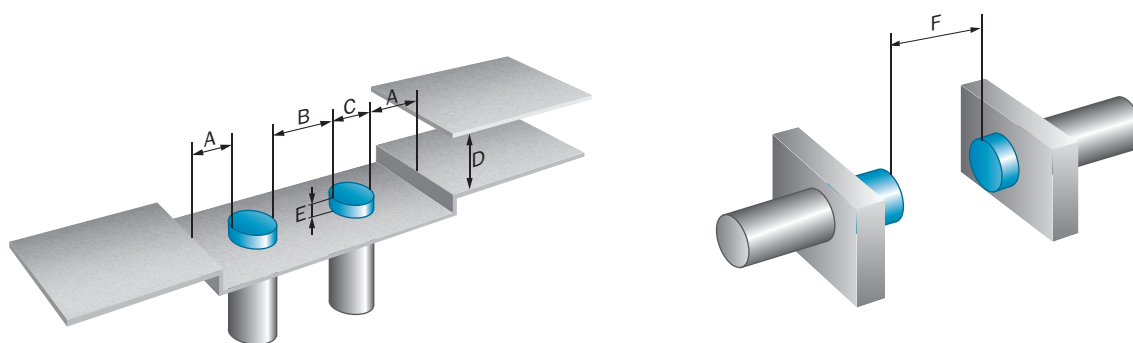

Connection type

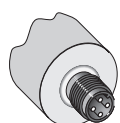

Connection diagram Cd-022

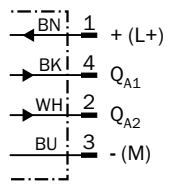

Temperature derating

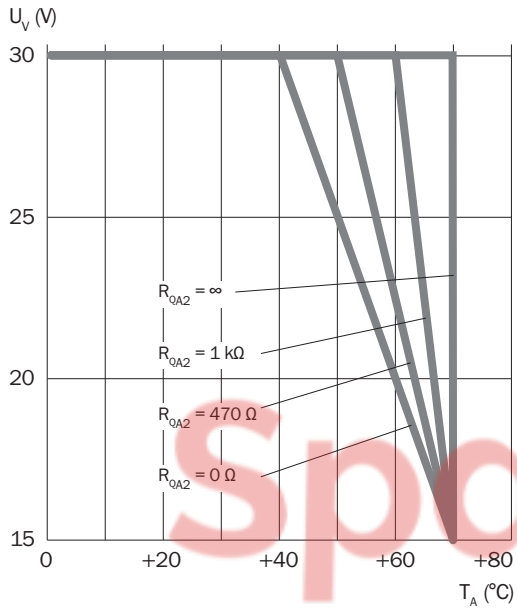

Response diagram Reduction factors

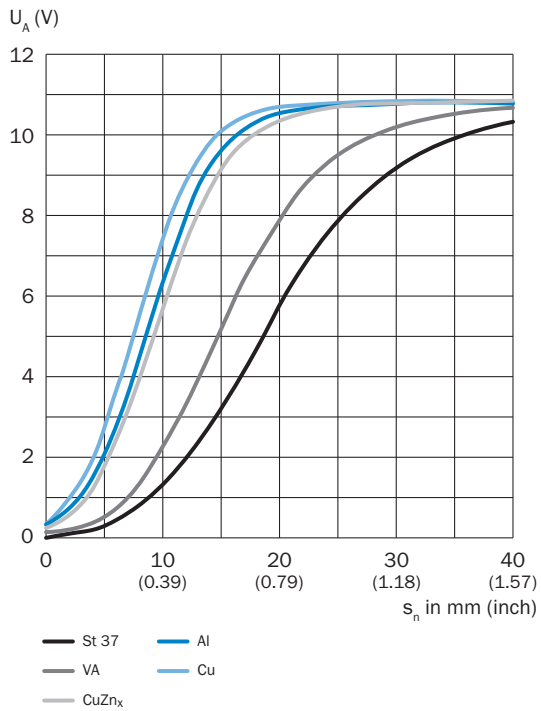

Dimensional drawing IMA30, connector, non-flush

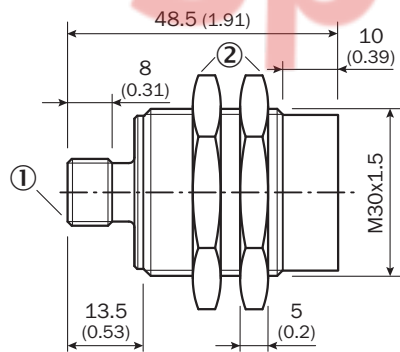















Dimensions in mm (inch)

- ① Connection
- ② Fastening nuts (2x); width across 36, metal

Recommended accessories

Other models and accessories → www.sick.com/IMA

	Brief description	Type	part no.
connectors and cables			
	<ul style="list-style-type: none"> Connection type head A: Female connector, M12, 4-pin, straight, A-coded Connection type head B: Flying leads Signal type: Sensor/actuator cable Cable: 2 m, 4-wire, PVC Description: Sensor/actuator cable, unshielded Application: Zones with chemicals, Uncontaminated zones 	YF2A14-020VB3XLEAX	2096234
	<ul style="list-style-type: none"> Connection type head A: Female connector, M12, 4-pin, straight, A-coded Connection type head B: Flying leads Signal type: Sensor/actuator cable Cable: 5 m, 4-wire, PVC Description: Sensor/actuator cable, unshielded Application: Zones with chemicals, Uncontaminated zones 	YF2A14-050VB3XLEAX	2096235
	<ul style="list-style-type: none"> Connection type head A: Female connector, M12, 4-pin, angled, A-coded Connection type head B: Flying leads Signal type: Sensor/actuator cable Cable: 2 m, 4-wire, PVC Description: Sensor/actuator cable, unshielded Application: Zones with chemicals, Uncontaminated zones 	YG2A14-020VB3XLEAX	2095895
	<ul style="list-style-type: none"> Connection type head A: Female connector, M12, 4-pin, angled, A-coded Connection type head B: Flying leads Signal type: Sensor/actuator cable Cable: 5 m, 4-wire, PVC Description: Sensor/actuator cable, unshielded Application: Zones with chemicals, Uncontaminated zones 	YG2A14-050VB3XLEAX	2095897
	<ul style="list-style-type: none"> Connection type head A: Female connector, M12, 4-pin, angled, A-coded Connection type head B: Flying leads Signal type: Sensor/actuator cable Cable: 0.6 m, 4-wire, PVC Description: Sensor/actuator cable, unshielded Application: Zones with chemicals, Uncontaminated zones 	YG2A14-C60VB3XLEAX	2145709
	<ul style="list-style-type: none"> Connection type head A: Female connector, M12, 4-pin, angled, A-coded Connection type head B: Flying leads Signal type: Sensor/actuator cable Cable: 1 m, 4-wire, PVC Description: Sensor/actuator cable, unshielded Application: Zones with chemicals, Uncontaminated zones 	YG2A14-010VB3XLEAX	2145710
	<ul style="list-style-type: none"> Connection type head A: Female connector, M12, 4-pin, straight, A-coded Connection type head B: Flying leads Signal type: Sensor/actuator cable Cable: 0.6 m, 4-wire, PVC Description: Sensor/actuator cable, unshielded Application: Zones with chemicals, Uncontaminated zones 	YF2A14-C60VB3XLEAX	2145707
	<ul style="list-style-type: none"> Connection type head A: Female connector, M12, 4-pin, straight, A-coded Connection type head B: Flying leads Signal type: Sensor/actuator cable Cable: 1 m, 4-wire, PVC Description: Sensor/actuator cable, unshielded Application: Zones with chemicals, Uncontaminated zones 	YF2A14-010VB3XLEAX	2145708
	<ul style="list-style-type: none"> Connection type head A: Female connector, M12, 4-pin, straight, A-coded Connection type head B: Flying leads Signal type: Sensor/actuator cable Cable: 5 m, 4-wire, PUR, halogen-free Description: Sensor/actuator cable, unshielded Application: Uncontaminated zones, Zones with oils and lubricants, Robot, Drag chain operation 	YF2A14-050UB3XLEAX	2095608
	<ul style="list-style-type: none"> Connection type head A: Female connector, M12, 4-pin, straight, A-coded Connection type head B: Flying leads Signal type: Sensor/actuator cable Cable: 0.6 m, 4-wire, PUR, halogen-free Description: Sensor/actuator cable, unshielded 	YF2A14-C60UB3XLEAX	2145654

	Brief description	Type	part no.
	<ul style="list-style-type: none"> Application: Untaminated zones, Zones with oils and lubricants, Robot, Drag chain operation Connection type head A: Female connector, M12, 4-pin, straight, A-coded Connection type head B: Flying leads Signal type: Sensor/actuator cable Cable: 1 m, 4-wire, PUR, halogen-free Description: Sensor/actuator cable, unshielded Application: Untaminated zones, Zones with oils and lubricants, Robot, Drag chain operation 	YF2A14-010UB3XLEAX	2145655
	<ul style="list-style-type: none"> Connection type head A: Female connector, M12, 4-pin, straight, A-coded Connection type head B: Flying leads Signal type: Sensor/actuator cable Cable: 3 m, 4-wire, PUR, halogen-free Description: Sensor/actuator cable, unshielded Application: Untaminated zones, Zones with oils and lubricants, Robot, Drag chain operation 	YF2A14-030UB3XLEAX	2145656
	<ul style="list-style-type: none"> Connection type head A: Female connector, M12, 4-pin, angled, A-coded Connection type head B: Flying leads Signal type: Sensor/actuator cable Cable: 0.6 m, 4-wire, PUR, halogen-free Description: Sensor/actuator cable, unshielded Application: Untaminated zones, Zones with oils and lubricants, Robot, Drag chain operation 	YG2A14-C60UB3XLEAX	2145657
	<ul style="list-style-type: none"> Connection type head A: Female connector, M12, 4-pin, angled, A-coded Connection type head B: Flying leads Signal type: Sensor/actuator cable Cable: 1 m, 4-wire, PUR, halogen-free Description: Sensor/actuator cable, unshielded Application: Untaminated zones, Zones with oils and lubricants, Robot, Drag chain operation 	YG2A14-010UB3XLEAX	2145658
Mounting systems			
	<ul style="list-style-type: none"> Description: Mounting bracket for M30 sensors Material: Steel Details: Steel, zinc coated Items supplied: Without mounting hardware 	BEF-WN-M30	5308445
	<ul style="list-style-type: none"> Description: Mounting plate for M30 sensors Material: Steel Details: Steel, zinc coated Items supplied: Without mounting hardware 	BEF-WG-M30	5321871

SICK AT A GLANCE

SICK is one of the leading manufacturers of intelligent sensors and sensor solutions for industrial applications. A unique range of products and services creates the perfect basis for controlling processes securely and efficiently, protecting individuals from accidents and preventing damage to the environment.

We have extensive experience in a wide range of industries and understand their processes and requirements. With intelligent sensors, we can deliver exactly what our customers need. In application centers in Europe, Asia and North America, system solutions are tested and optimized in accordance with customer specifications. All this makes us a reliable supplier and development partner.

Comprehensive services complete our offering: SICK LifeTime Services provide support throughout the machine life cycle and ensure safety and productivity.

For us, that is “Sensor Intelligence.”

WORLDWIDE PRESENCE:

Contacts and other locations – www.sick.com

SpareCruX