

IMA18-20NE1ZC0K

IMA

INDUCTIVE PROXIMITY SENSORS

**SICK**  
Sensor Intelligence.

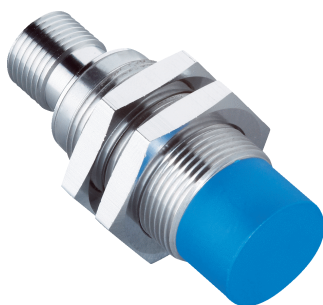

### Ordering information

Type	part no.
IMA18-20NE1ZCOK	6041794

Other models and accessories → [www.sick.com/IMA](http://www.sick.com/IMA)

Illustration may differ



### Detailed technical data

#### Features

<b>Housing</b>	Metric
<b>Thread size</b>	M18 x 1
<b>Diameter</b>	Ø 18 mm
<b>Sensing range <math>S_n</math></b>	0 mm ... 20 mm
<b>Installation type</b>	Non-flush
<b>Connection type</b>	Male connector M12, 4-pin
<b>Output function</b>	Analog
<b>Repeatability (<math>T_a</math> not constant)</b>	0.3 mm <sup>1) 2) 3)</sup>
<b>Repeatability (<math>T_a</math> constant)</b>	± 0.05 mm
<b>Resolution</b>	≤ 5 µm
<b>Enclosure rating</b>	IP67 <sup>4)</sup>
<b>Special features</b>	Analog output, triple sensing range
<b>Items supplied</b>	Mounting nut, brass, chromium-plated (2x) Toothed washer, stainless steel (2 x)

<sup>1)</sup> As per IEC 60947-5-2.

<sup>2)</sup>  $U_b = DC 20 V \dots 30 V$ .

<sup>3)</sup>  $T_A = 23 \text{ °C} \pm 5 \text{ °C}$ .

<sup>4)</sup> According to EN 60529: 2000-09.

#### Mechanics/electronics

<b>Supply voltage</b>	15 V DC ... 30 V DC
<b>Ripple</b>	≤ 20 % <sup>1)</sup>

<sup>1)</sup> Of  $V_s$ .

<sup>2)</sup> Without load.

<sup>3)</sup> At voltage output QA1.

<sup>4)</sup> -3 dB if  $S_n = 10 \text{ mm}$ .

<sup>5)</sup> QA1 loaded, QA2 unloaded.

<sup>6)</sup> QA1 loaded, QA2 loaded: see temperature reduction.

<b>Time delay before availability</b>	≤ 60 ms
<b>Temperature drift (of S<sub>i</sub>)</b>	≤ 10 %
<b>No load current</b>	≤ 12 mA <sup>2)</sup>
<b>Load current</b>	± 10 mA <sup>3)</sup>
<b>Max. load resistance</b>	≤ 400 Ω U <sub>b</sub> = 15 V ≤ 1,000 Ω U <sub>b</sub> = 30 V
<b>Output voltage Q<sub>A1</sub></b>	s = 0 mm: 0 V/-0 +0,4 V (23 °C) s = 10 mm: +5,2 V/ +0,4 V (23 °C) s = 20 mm: +10 V/ +0,4 V (23 °C)
<b>Output current Q<sub>A2</sub></b>	s = 0 mm: 4 mA/ +0,8 mA (23 °C) s = 20 mm: 20 mA +/-0,8 mA (23 °C)
<b>Output voltage</b>	0 V ... 10 V
<b>Bandwidth</b>	250 Hz <sup>4)</sup>
<b>Short-circuit protection</b>	✓
<b>Ambient operating temperature</b>	-25 °C ... +70 °C <sup>5) 6)</sup>
<b>Housing material</b>	Brass, chromium-plated
<b>Sensing face material</b>	Plastic, PTB
<b>Housing length</b>	48.5 mm
<b>Thread length</b>	22 mm

1) Of V<sub>S</sub>.

2) Without load.

3) At voltage output QA1.

4) -3 dB if S<sub>n</sub> = 10 mm.

5) QA1 loaded, QA2 unloaded.

6) QA1 loaded, QA2 loaded: see temperature reduction.

SpareCruX

#### Safety-related parameters

<b>MTTF<sub>D</sub></b>	88 years
<b>DC<sub>avg</sub></b>	0%
<b>T<sub>M</sub> (mission time)</b>	20 years

#### Reduction factors

<b>Note</b>	The values are reference values which may vary
<b>Stainless steel (V2A, 304)</b>	Approx. 0.69
<b>Aluminum (Al)</b>	Approx. 0.38
<b>Copper (Cu)</b>	Approx. 0.36
<b>Brass (Br)</b>	Approx. 0.46

#### Installation note

<b>Remark</b>	Associated graphic see "Installation"
<b>A</b>	21 mm
<b>B</b>	60 mm
<b>C</b>	18 mm
<b>D</b>	60 mm
<b>E</b>	20 mm
<b>F</b>	200 mm

Certificates

<b>EU declaration of conformity</b>	✓
<b>UK declaration of conformity</b>	✓
<b>ACMA declaration of conformity</b>	✓
<b>Moroccan declaration of conformity</b>	✓
<b>China RoHS</b>	✓

Classifications

<b>ECLASS 5.0</b>	27270101
<b>ECLASS 5.1.4</b>	27270101
<b>ECLASS 6.0</b>	27270101
<b>ECLASS 6.2</b>	27270101
<b>ECLASS 7.0</b>	27270101
<b>ECLASS 8.0</b>	27270101
<b>ECLASS 8.1</b>	27270101
<b>ECLASS 9.0</b>	27270101
<b>ECLASS 10.0</b>	27270101
<b>ECLASS 11.0</b>	27270101
<b>ECLASS 12.0</b>	27274001
<b>ETIM 5.0</b>	EC002714
<b>ETIM 6.0</b>	EC002714
<b>ETIM 7.0</b>	EC002714
<b>ETIM 8.0</b>	EC002714
<b>UNSPSC 16.0901</b>	39122230



Installation note Non-flush installation

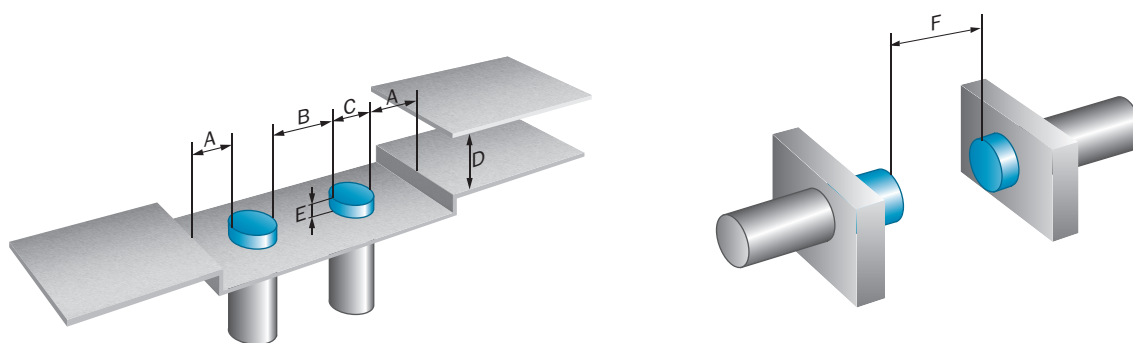

Connection type

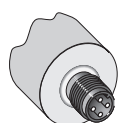

### Connection diagram Cd-022

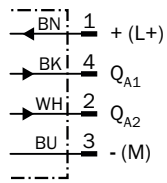

### Response diagram Reduction factors

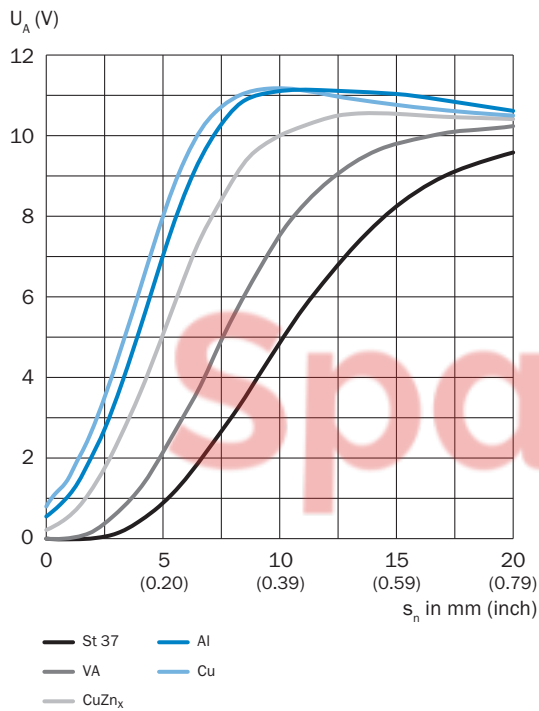

### Dimensional drawing IMA18, connector, non-flush

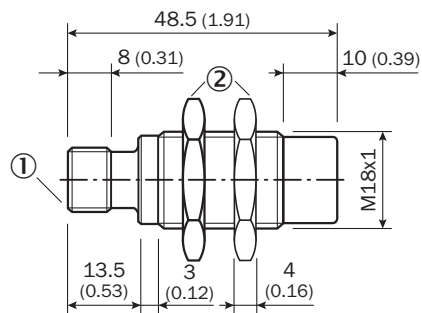

Dimensions in mm (inch)









① Connection









② Fastening nuts (2x); width across 24, metal

SpareCruX

Recommended accessories

Other models and accessories → [www.sick.com/IMA](http://www.sick.com/IMA)

	Brief description	Type	part no.
connectors and cables			
	<ul style="list-style-type: none"> <li>• <b>Connection type head A:</b> Female connector, M12, 4-pin, straight, A-coded</li> <li>• <b>Connection type head B:</b> Flying leads</li> <li>• <b>Signal type:</b> Sensor/actuator cable</li> <li>• <b>Cable:</b> 2 m, 4-wire, PVC</li> <li>• <b>Description:</b> Sensor/actuator cable, unshielded</li> <li>• <b>Application:</b> Zones with chemicals, Uncontaminated zones</li> </ul>	YF2A14-020VB3XLEAX	2096234
	<ul style="list-style-type: none"> <li>• <b>Connection type head A:</b> Female connector, M12, 4-pin, straight, A-coded</li> <li>• <b>Connection type head B:</b> Flying leads</li> <li>• <b>Signal type:</b> Sensor/actuator cable</li> <li>• <b>Cable:</b> 5 m, 4-wire, PVC</li> <li>• <b>Description:</b> Sensor/actuator cable, unshielded</li> <li>• <b>Application:</b> Zones with chemicals, Uncontaminated zones</li> </ul>	YF2A14-050VB3XLEAX	2096235
	<ul style="list-style-type: none"> <li>• <b>Connection type head A:</b> Female connector, M12, 4-pin, angled, A-coded</li> <li>• <b>Connection type head B:</b> Flying leads</li> <li>• <b>Signal type:</b> Sensor/actuator cable</li> <li>• <b>Cable:</b> 2 m, 4-wire, PVC</li> <li>• <b>Description:</b> Sensor/actuator cable, unshielded</li> <li>• <b>Application:</b> Zones with chemicals, Uncontaminated zones</li> </ul>	YG2A14-020VB3XLEAX	2095895
	<ul style="list-style-type: none"> <li>• <b>Connection type head A:</b> Female connector, M12, 4-pin, angled, A-coded</li> <li>• <b>Connection type head B:</b> Flying leads</li> <li>• <b>Signal type:</b> Sensor/actuator cable</li> <li>• <b>Cable:</b> 5 m, 4-wire, PVC</li> <li>• <b>Description:</b> Sensor/actuator cable, unshielded</li> <li>• <b>Application:</b> Zones with chemicals, Uncontaminated zones</li> </ul>	YG2A14-050VB3XLEAX	2095897
	<ul style="list-style-type: none"> <li>• <b>Connection type head A:</b> Female connector, M12, 4-pin, angled, A-coded</li> <li>• <b>Connection type head B:</b> Flying leads</li> <li>• <b>Signal type:</b> Sensor/actuator cable</li> <li>• <b>Cable:</b> 0.6 m, 4-wire, PVC</li> <li>• <b>Description:</b> Sensor/actuator cable, unshielded</li> <li>• <b>Application:</b> Zones with chemicals, Uncontaminated zones</li> </ul>	YG2A14- C60VB3XLEAX	2145709
	<ul style="list-style-type: none"> <li>• <b>Connection type head A:</b> Female connector, M12, 4-pin, angled, A-coded</li> <li>• <b>Connection type head B:</b> Flying leads</li> <li>• <b>Signal type:</b> Sensor/actuator cable</li> <li>• <b>Cable:</b> 1 m, 4-wire, PVC</li> <li>• <b>Description:</b> Sensor/actuator cable, unshielded</li> <li>• <b>Application:</b> Zones with chemicals, Uncontaminated zones</li> </ul>	YG2A14-010VB3XLEAX	2145710
	<ul style="list-style-type: none"> <li>• <b>Connection type head A:</b> Female connector, M12, 4-pin, straight, A-coded</li> <li>• <b>Connection type head B:</b> Flying leads</li> <li>• <b>Signal type:</b> Sensor/actuator cable</li> <li>• <b>Cable:</b> 0.6 m, 4-wire, PVC</li> <li>• <b>Description:</b> Sensor/actuator cable, unshielded</li> <li>• <b>Application:</b> Zones with chemicals, Uncontaminated zones</li> </ul>	YF2A14- C60VB3XLEAX	2145707
	<ul style="list-style-type: none"> <li>• <b>Connection type head A:</b> Female connector, M12, 4-pin, straight, A-coded</li> <li>• <b>Connection type head B:</b> Flying leads</li> <li>• <b>Signal type:</b> Sensor/actuator cable</li> <li>• <b>Cable:</b> 1 m, 4-wire, PVC</li> <li>• <b>Description:</b> Sensor/actuator cable, unshielded</li> <li>• <b>Application:</b> Zones with chemicals, Uncontaminated zones</li> </ul>	YF2A14-010VB3XLEAX	2145708
	<ul style="list-style-type: none"> <li>• <b>Connection type head A:</b> Female connector, M12, 4-pin, straight, A-coded</li> <li>• <b>Connection type head B:</b> Flying leads</li> <li>• <b>Signal type:</b> Sensor/actuator cable</li> <li>• <b>Cable:</b> 5 m, 4-wire, PUR, halogen-free</li> <li>• <b>Description:</b> Sensor/actuator cable, unshielded</li> <li>• <b>Application:</b> Uncontaminated zones, Zones with oils and lubricants, Robot, Drag chain operation</li> </ul>	YF2A14-050UB3XLEAX	2095608
	<ul style="list-style-type: none"> <li>• <b>Connection type head A:</b> Female connector, M12, 4-pin, straight, A-coded</li> <li>• <b>Connection type head B:</b> Flying leads</li> <li>• <b>Signal type:</b> Sensor/actuator cable</li> <li>• <b>Cable:</b> 0.6 m, 4-wire, PUR, halogen-free</li> <li>• <b>Description:</b> Sensor/actuator cable, unshielded</li> </ul>	YF2A14- C60UB3XLEAX	2145654

	Brief description	Type	part no.
	<ul style="list-style-type: none"> <li><b>Application:</b> Uncontaminated zones, Zones with oils and lubricants, Robot, Drag chain operation</li> <li><b>Connection type head A:</b> Female connector, M12, 4-pin, straight, A-coded</li> <li><b>Connection type head B:</b> Flying leads</li> <li><b>Signal type:</b> Sensor/actuator cable</li> <li><b>Cable:</b> 1 m, 4-wire, PUR, halogen-free</li> <li><b>Description:</b> Sensor/actuator cable, unshielded</li> <li><b>Application:</b> Uncontaminated zones, Zones with oils and lubricants, Robot, Drag chain operation</li> </ul>	YF2A14-010UB3XLEAX	2145655
	<ul style="list-style-type: none"> <li><b>Connection type head A:</b> Female connector, M12, 4-pin, straight, A-coded</li> <li><b>Connection type head B:</b> Flying leads</li> <li><b>Signal type:</b> Sensor/actuator cable</li> <li><b>Cable:</b> 3 m, 4-wire, PUR, halogen-free</li> <li><b>Description:</b> Sensor/actuator cable, unshielded</li> <li><b>Application:</b> Uncontaminated zones, Zones with oils and lubricants, Robot, Drag chain operation</li> </ul>	YF2A14-030UB3XLEAX	2145656
	<ul style="list-style-type: none"> <li><b>Connection type head A:</b> Female connector, M12, 4-pin, angled, A-coded</li> <li><b>Connection type head B:</b> Flying leads</li> <li><b>Signal type:</b> Sensor/actuator cable</li> <li><b>Cable:</b> 0.6 m, 4-wire, PUR, halogen-free</li> <li><b>Description:</b> Sensor/actuator cable, unshielded</li> <li><b>Application:</b> Uncontaminated zones, Zones with oils and lubricants, Robot, Drag chain operation</li> </ul>	YG2A14-C60UB3XLEAX	2145657
	<ul style="list-style-type: none"> <li><b>Connection type head A:</b> Female connector, M12, 4-pin, angled, A-coded</li> <li><b>Connection type head B:</b> Flying leads</li> <li><b>Signal type:</b> Sensor/actuator cable</li> <li><b>Cable:</b> 1 m, 4-wire, PUR, halogen-free</li> <li><b>Description:</b> Sensor/actuator cable, unshielded</li> <li><b>Application:</b> Uncontaminated zones, Zones with oils and lubricants, Robot, Drag chain operation</li> </ul>	YG2A14-010UB3XLEAX	2145658
<b>Mounting systems</b>			
	<ul style="list-style-type: none"> <li><b>Description:</b> Clamping block for round sensors M18, with fixed stop</li> <li><b>Material:</b> Plastic</li> <li><b>Details:</b> Plastic (PA12), glass-fiber reinforced</li> <li><b>Items supplied:</b> Mounting hardware included</li> <li><b>Suitable for:</b> GR18, MH15V, V180-2, V18</li> </ul>	BEF-KHF-M18	2051482
	<ul style="list-style-type: none"> <li><b>Description:</b> Clamping block for round sensors M18, without fixed stop</li> <li><b>Material:</b> Plastic</li> <li><b>Details:</b> Plastic (PA12), glass-fiber reinforced</li> <li><b>Items supplied:</b> Mounting hardware included</li> <li><b>Suitable for:</b> GR18, MH15V, V180-2, V18</li> </ul>	BEF-KH-M18	2051481
	<ul style="list-style-type: none"> <li><b>Description:</b> Mounting bracket for M18 sensors</li> <li><b>Material:</b> Steel</li> <li><b>Details:</b> Steel, zinc coated</li> <li><b>Items supplied:</b> Without mounting hardware</li> <li><b>Suitable for:</b> GR18, V180-2, V18, W15, Z1, Z2</li> </ul>	BEF-WN-M18	5308446
	<ul style="list-style-type: none"> <li><b>Description:</b> Plate N06 for universal clamp bracket, M18</li> <li><b>Material:</b> Steel, zinc diecast</li> <li><b>Details:</b> Zinc plated steel (sheet), Zinc die cast (clamping bracket)</li> <li><b>Items supplied:</b> Universal clamp (5322626), mounting hardware</li> <li><b>Usable for:</b> MH15, MH15V, V180-2, V18V, W15, GR18, V18, V18 Laser, V12-2, SimpleSense, SureSense, M18 round sensors</li> </ul>	BEF-KHS-N06	2051612
	<ul style="list-style-type: none"> <li><b>Description:</b> Mounting bracket with ball-and-socket</li> <li><b>Material:</b> Plastic</li> <li><b>Details:</b> Plastic</li> <li><b>Items supplied:</b> Mounting hardware included</li> <li><b>Suitable for:</b> GR18, MH15V, V180-2, V18</li> </ul>	BEF-WN-M18-ST02	5312973
	<ul style="list-style-type: none"> <li><b>Description:</b> Mounting bracket for M18 sensors</li> <li><b>Material:</b> Stainless steel</li> <li><b>Details:</b> Stainless steel</li> <li><b>Items supplied:</b> Without mounting hardware</li> </ul>	BEF-WN-M18N	5320947

## SICK AT A GLANCE

SICK is one of the leading manufacturers of intelligent sensors and sensor solutions for industrial applications. A unique range of products and services creates the perfect basis for controlling processes securely and efficiently, protecting individuals from accidents and preventing damage to the environment.

We have extensive experience in a wide range of industries and understand their processes and requirements. With intelligent sensors, we can deliver exactly what our customers need. In application centers in Europe, Asia and North America, system solutions are tested and optimized in accordance with customer specifications. All this makes us a reliable supplier and development partner.

Comprehensive services complete our offering: SICK LifeTime Services provide support throughout the machine life cycle and ensure safety and productivity.

For us, that is “Sensor Intelligence.”

### WORLDWIDE PRESENCE:

Contacts and other locations – [www.sick.com](http://www.sick.com)

SpareCruX