



# WL8G-P1131

W8G

PHOTOELECTRIC SENSORS

**SICK**  
Sensor Intelligence.



Illustration may differ



## Ordering information

| Type       | part no. |
|------------|----------|
| WL8G-P1131 | 6033184  |

**Included in delivery:** BEF-W100-A (1), P250F (1)

Other models and accessories → [www.sick.com/W8G](http://www.sick.com/W8G)

## Detailed technical data

### Features

|  |   |
|--|---|
| <b>Functional principle</b>            | Photoelectric retro-reflective sensor                               |
| <b>Functional principle detail</b>     | Without reflector minimum distance (autocollimation/coaxial optics) |
| <b>Dimensions (W x H x D)</b>          | 11 mm x 31 mm x 20 mm   |
| <b>Housing design (light emission)</b> | Rectangular   |
| <b>Sensing range max.</b>              | 0 m ... 3 m <sup>1)</sup>   |
| <b>Sensing range</b>                   | 0 ... 1.7 m <sup>1)</sup>   |
| <b>Type of light</b>                   | Visible red light   |
| <b>Light source</b>                    | LED <sup>2)</sup>   |
| <b>Light spot size (distance)</b>      | Ø 70 mm (2 m)   |
| <b>Wave length</b>                     | 650 nm  |
| <b>Adjustment</b>                      | Potentiometer, 270°   |
| <b>Special feature</b>                 | Detecting transparent objects                                       |
| <b>Special applications</b>            | Detecting transparent objects                                       |

<sup>1)</sup> Reflector PL80A.

<sup>2)</sup> Average service life: 100,000 h at T<sub>U</sub> = +25 °C.

## Mechanics/electronics

|   |   |
|---|---|
| <b>Supply voltage <math>U_B</math></b>      | 10 V DC ... 30 V DC <sup>1)</sup>   |
| <b>Ripple</b>                               | $\pm 10\%$ <sup>2)</sup>  |
| <b>Current consumption</b>                  | 30 mA <sup>3)</sup>   |
| <b>Switching output</b>                     | PNP   |
| <b>Switching mode</b>                       | Light/dark switching  |
| <b>Switching mode selector</b>              | Selectable via light/dark rotary switch                                   |
| <b>Signal voltage PNP HIGH/LOW</b>          | Approx. $V_S - 1.8\text{ V} / 0\text{ V}$                                 |
| <b>Output current <math>I_{\max}</math></b> | $\leq 100\text{ mA}$  |
| <b>Response time</b>                        | $\leq 0.5\text{ ms}$ <sup>4)</sup>  |
| <b>Switching frequency</b>                  | 1,000 Hz <sup>5)</sup>  |
| <b>Attenuation along light beam</b>         | $\leq 20\%$   |
| <b>Connection type</b>                      | Cable, 3-wire, 2 m <sup>6)</sup>  |
| <b>Cable material</b>                       | Plastic, PVC  |
| <b>Circuit protection</b>                   | A <sup>7)</sup><br>B <sup>8)</sup><br>D <sup>9)</sup>                     |
| <b>Weight</b>                               | 50 g  |
| <b>Polarizing filter</b>                    | ✓   |
| <b>Housing material</b>                     | Plastic, ABS  |
| <b>Optics material</b>                      | Plastic, PMMA   |
| <b>Enclosure rating</b>                     | IP67  |
| <b>Items supplied</b>                       | Stainless steel mounting bracket (1.4301/304) BEF-W100-A, Reflector P250F |
| <b>Special feature</b>                      | Detecting transparent objects   |
| <b>Ambient operating temperature</b>        | $-25\text{ °C} \dots +55\text{ °C}$                                       |
| <b>Ambient temperature, storage</b>         | $-40\text{ °C} \dots +70\text{ °C}$                                       |

<sup>1)</sup> Limit values when operated in short-circuit protected network: max. 8 A.

<sup>2)</sup> May not fall below or exceed  $U_V$  tolerances.

<sup>3)</sup> Without load.

<sup>4)</sup> Signal transit time with resistive load.

<sup>5)</sup> With light/dark ratio 1:1.

<sup>6)</sup> Do not bend below 0 °C.

<sup>7)</sup> A =  $V_S$  connections reverse-polarity protected.

<sup>8)</sup> B = inputs and output reverse-polarity protected.

<sup>9)</sup> D = outputs overcurrent and short-circuit protected.

## Safety-related parameters

|                         |               |
|-------------------------|---------------|
| <b>MTTF<sub>D</sub></b> | 1,028.4 years |
| <b>DC<sub>avg</sub></b> | 0 %           |

## Certificates

|                                       |   |
|---------------------------------------|---|
| <b>EU declaration of conformity</b>   | ✓ |
| <b>UK declaration of conformity</b>   | ✓ |
| <b>ACMA declaration of conformity</b> | ✓ |

|  |   |
|--|---|
| <b>Moroccan declaration of conformity</b>                | ✓ |
| <b>China RoHS</b>  | ✓ |
| <b>Photobiological safety (DIN EN 62471) certificate</b> | ✓ |

### Classifications

|                       |          |
|-----------------------|----------|
| <b>ECLASS 5.0</b>     | 27270902 |
| <b>ECLASS 5.1.4</b>   | 27270902 |
| <b>ECLASS 6.0</b>     | 27270902 |
| <b>ECLASS 6.2</b>     | 27270902 |
| <b>ECLASS 7.0</b>     | 27270902 |
| <b>ECLASS 8.0</b>     | 27270902 |
| <b>ECLASS 8.1</b>     | 27270902 |
| <b>ECLASS 9.0</b>     | 27270902 |
| <b>ECLASS 10.0</b>    | 27270902 |
| <b>ECLASS 11.0</b>    | 27270902 |
| <b>ECLASS 12.0</b>    | 27270902 |
| <b>ETIM 5.0</b>       | EC002717 |
| <b>ETIM 6.0</b>       | EC002717 |
| <b>ETIM 7.0</b>       | EC002717 |
| <b>ETIM 8.0</b>       | EC002717 |
| <b>UNSPSC 16.0901</b> | 39121528 |

SpareCruX

### Adjustments

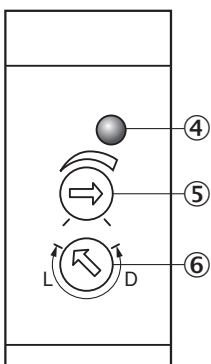

- ④ Orange LED indicator : switching output active
- ⑤ sensitivity control
- ⑥ Light/ dark rotary switch: L = light switching, D = dark switching

### Connection type

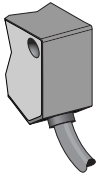

### Connection diagram Cd-043

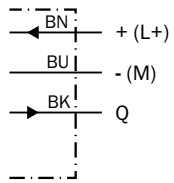

### Characteristic curve WL8G

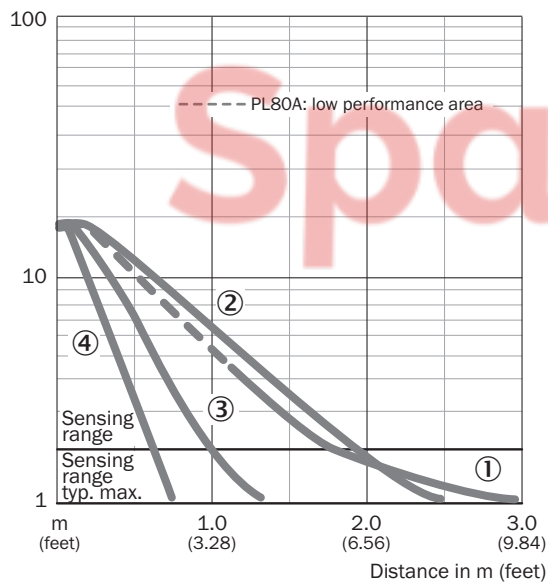

- ① Reflector PL80A
- ② Reflector P250F
- ③ Reflector PL20F
- ④ PL10F reflector

Sensing range diagram WL8G

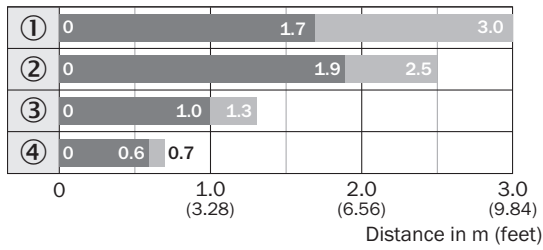

■ Sensing range      ■ Sensing range typ. max.

- ① Reflector PL80A
- ② Reflector P250F
- ③ Reflector PL20F
- ④ PL10F reflector

Dimensional drawing

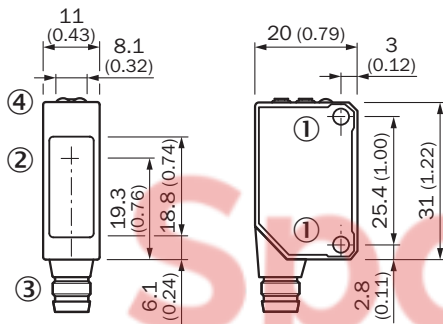







Dimensions in mm (inch)

- ① Threaded mounting hole M3, max. tightening torque: 0.6 Nm
- ② Center of optical axis
- ③ Connection
- ④ Orange LED indicator : switching output active

## Recommended accessories

Other models and accessories → [www.sick.com/W8G](http://www.sick.com/W8G)

|   | Brief description  | Type         | part no. |
|---|--|--------------|----------|
| Mounting systems  |  |              |          |
|    | <ul style="list-style-type: none"> <li><b>Description:</b> Universal mounting bracket for reflectors</li> <li><b>Dimensions (W x H x L):</b> 85 mm x 90 mm x 35 mm</li> <li><b>Material:</b> Steel</li> <li><b>Details:</b> Steel, zinc coated</li> <li><b>Suitable for:</b> C110A, P250, PL20, PL30A, PL40A, PL80A</li> </ul>   | BEF-WN-REFX  | 2064574  |
|    | <ul style="list-style-type: none"> <li><b>Description:</b> Mounting bracket for wall mounting</li> <li><b>Material:</b> Stainless steel</li> <li><b>Details:</b> Stainless steel</li> <li><b>Items supplied:</b> Mounting hardware included</li> <li><b>Suitable for:</b> W8, W8G, W8 Laser, W8 Inox, G6, G6 Inox, W100 Laser, W100-2, KTM Core, KTM Prime, CSM, LUTM, W4S</li> </ul>  | BEF-W100-A   | 5311520  |
|    | <ul style="list-style-type: none"> <li><b>Description:</b> Plate N08 for universal clamp bracket</li> <li><b>Material:</b> Steel, zinc diecast</li> <li><b>Details:</b> Zinc plated steel (sheet), Zinc die cast (clamping bracket)</li> <li><b>Items supplied:</b> Universal clamp (5322626), mounting hardware</li> <li><b>Usable for:</b> W100, W150, W4S, W4F, W8, W9-3, W8G, W8 Laser, W8 Inox, G6, W100 Laser, W100-2, W10, G6 Inox, RAY10, W4SLG-3, W9, GR18, MultiPulse, Reflex Array, MultiLine, LUT3, KT5, KT8, KT10, CS8</li> </ul> | BEF-KHS-N08  | 2051607  |
|   | <ul style="list-style-type: none"> <li><b>Description:</b> Plate N11N for universal clamp bracket</li> <li><b>Material:</b> Stainless steel</li> <li><b>Details:</b> Stainless steel 1.4571 (sheet), Stainless steel 1.4408 (clamp)</li> <li><b>Items supplied:</b> Universal clamp (5322627), mounting hardware</li> <li><b>Usable for:</b> DeltaPac, Glare, WTD20E</li> </ul>  | BEF-KHS-N11N | 2071081  |
| reflectors and optics   |  |              |          |
|  | <ul style="list-style-type: none"> <li><b>Description:</b> Fine triple reflector, screw connection, suitable for laser sensors</li> <li><b>Dimensions:</b> 52 mm 62 mm</li> <li><b>Ambient operating temperature:</b> -30 °C ... +65 °C</li> </ul>   | P250F        | 5308843  |
| connectors and cables   |  |              |          |
|  | <ul style="list-style-type: none"> <li><b>Connection type head A:</b> Male connector, M8, 3-pin, straight, A-coded</li> <li><b>Description:</b> Unshielded</li> <li><b>Connection systems:</b> Screw-type terminals</li> <li><b>Permitted cross-section:</b> 0.14 mm<sup>2</sup> ... 0.5 mm<sup>2</sup></li> </ul>   | STE-0803-G   | 6037322  |

## SICK AT A GLANCE

SICK is one of the leading manufacturers of intelligent sensors and sensor solutions for industrial applications. A unique range of products and services creates the perfect basis for controlling processes securely and efficiently, protecting individuals from accidents and preventing damage to the environment.

We have extensive experience in a wide range of industries and understand their processes and requirements. With intelligent sensors, we can deliver exactly what our customers need. In application centers in Europe, Asia and North America, system solutions are tested and optimized in accordance with customer specifications. All this makes us a reliable supplier and development partner.

Comprehensive services complete our offering: SICK LifeTime Services provide support throughout the machine life cycle and ensure safety and productivity.

For us, that is “Sensor Intelligence.”

### WORLDWIDE PRESENCE:

Contacts and other locations – [www.sick.com](http://www.sick.com)

SpareCruX