



i10-HB213

i10H

ELECTRO-MECHANICAL SAFETY SWITCHES

SICK
Sensor Intelligence.

Ordering information



Type	part no.
i10-HB213	6025053

Other models and accessories → www.sick.com/i10H



Detailed technical data

Features

Positive action N/C contacts	2
N/O contacts	1
Actuation frequency	≤ 3,600 /h
Actuation torque	≥ 0.08 Nm
Directions of rotation	2
Switching angle	Adjustable 5° ... 14°

Safety-related parameters

B_{10d} parameter	2 x 10 ⁶ switching cycles (with small load)
Type	Type 1 (EN ISO 14119)
Actuator coding level	Uncoded (EN ISO 14119)
Safe state in the event of a fault	The switch has no internal fault detection and is unable to assume a safe state in the event of a fault. Fault detection is performed by the connected safety-related logic unit.

Functions

Safe series connection	None, only individual wiring (with diagnostics)
-------------------------------	---

Interfaces

Connection type	Cable gland, 1 x M16
------------------------	----------------------

Electronics

Switching principle	Slow action switching element
Usage category	AC-15/DC-13 (IEC 60947-5-1)
Rated operating current (voltage)	3 A (240 V AC) 2 A (24 V DC)
Rated insulation voltage U_i	250 V
Rated impulse withstand voltage U_{imp}	2,500 V AC
Short-circuit protection	3 A gG
Switching voltage	≥ 5 V DC

Switching current (switching voltage)	5 mA (5 V DC)
--	---------------

Mechanics

Weight	0.17 kg
Housing material	Glass-fiber reinforced polyester
Mechanical life	1 x 10 ⁶ switching cycles

Ambient data

Enclosure rating	IP67 (IEC 60529)
Ambient operating temperature	-20 °C ... +80 °C
Storage temperature	-20 °C ... +80 °C

Certificates

EU declaration of conformity	✓
UK declaration of conformity	✓
cULus certificate	✓

Classifications

ECLASS 5.0	27272601
ECLASS 5.1.4	27272601
ECLASS 6.0	27272601
ECLASS 6.2	27272601
ECLASS 7.0	27272601
ECLASS 8.0	27272601
ECLASS 8.1	27272601
ECLASS 9.0	27272601
ECLASS 10.0	27272601
ECLASS 11.0	27272601
ECLASS 12.0	27272601
ETIM 5.0	EC001829
ETIM 6.0	EC001829
ETIM 7.0	EC001829
ETIM 8.0	EC001829
UNSPSC 16.0901	39122205

Dimensional drawing

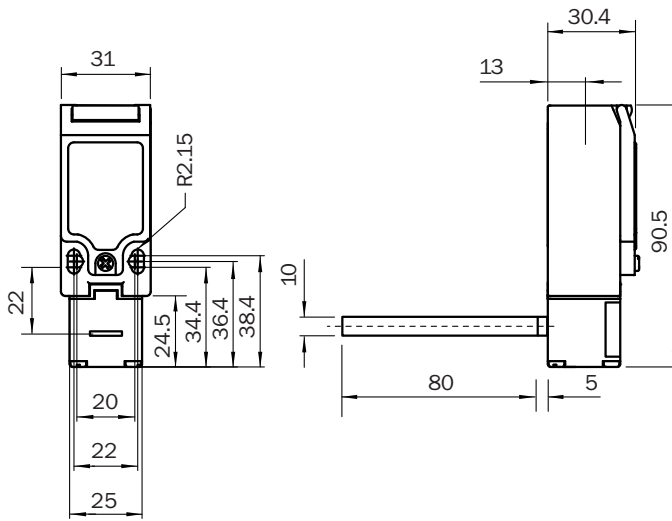

Dimensions in mm (inch)

Actuator travel diagram

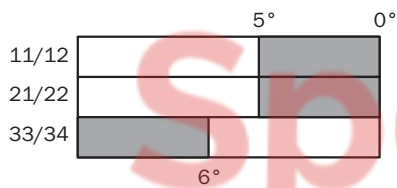

- Contacts open
- Contacts closed

Switching elements

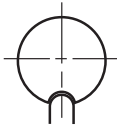
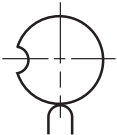
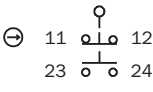
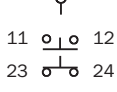
	Not actuated	Actuated
Switching element 11		
Switching element 21		

Switching element 11:
1 positive action N/C contact + 1 N/O contact

Switching element 21:
2 positive action N/C contacts + 1 N/O contact



Adjustments

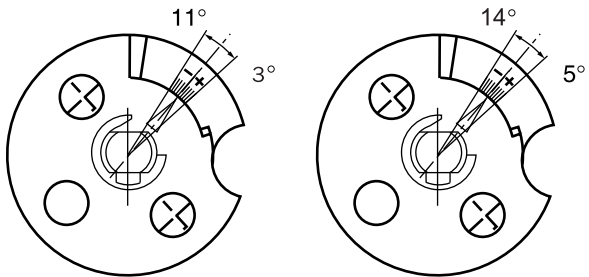

SICK AT A GLANCE

SICK is one of the leading manufacturers of intelligent sensors and sensor solutions for industrial applications. A unique range of products and services creates the perfect basis for controlling processes securely and efficiently, protecting individuals from accidents and preventing damage to the environment.

We have extensive experience in a wide range of industries and understand their processes and requirements. With intelligent sensors, we can deliver exactly what our customers need. In application centers in Europe, Asia and North America, system solutions are tested and optimized in accordance with customer specifications. All this makes us a reliable supplier and development partner.

Comprehensive services complete our offering: SICK LifeTime Services provide support throughout the machine life cycle and ensure safety and productivity.

For us, that is “Sensor Intelligence.”

WORLDWIDE PRESENCE:

Contacts and other locations – www.sick.com

SpareCruX