



WTB26I-39422122ZZZ

W26

PHOTOELECTRIC SENSORS

SICK
Sensor Intelligence.

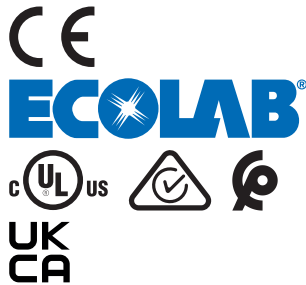

Illustration may differ

Ordering information

Type	part no.
WTB26I-39422122ZZZ	1222810

Other models and accessories → www.sick.com/W26



Detailed technical data

Features

Functional principle	Photoelectric proximity sensor
Functional principle detail	Background suppression
Sensing range	
Sensing range min.	30 mm
Sensing range max.	2,000 mm
Adjustable switching threshold for background suppression	180 mm ... 2,000 mm
Reference object	Object with 90% remission factor (complies with standard white according to DIN 5033)
Minimum distance between set sensing range and background (black 6% / white 90%)	85 mm, at a distance of 800 mm
Recommended sensing range for the best performance	200 mm ... 800 mm
Emitted beam	
Light source	LED
Type of light	Infrared light
Shape of light spot	Point-shaped
Light spot size (distance)	Ø 14 mm (1,000 mm)
Maximum dispersion of the emitted beam around the standardized transmission axis (squint angle)	< +/- 1.0° (at Ta = +23 °C)
Key LED figures	
Normative reference	EN 62471:2008-09 IEC 62471:2006, modified
LED risk group marking	Free group

Wave length	850 nm
Average service life	100,000 h at $T_a = +25\text{ °C}$
Adjustment	
Teach-Turn adjustment 1	BluePilot: For setting the sensing range
Teach-Turn adjustment 2	BluePilot: for configuring the time function
Wire/pin	For activating the test input
Display	
LED blue 1	BluePilot: sensing range indicator
LED blue 2	BluePilot: Time function display
LED green	Operating indicator Static on: power on
LED yellow	Status of received light beam Static on: object present Static off: object not present

Safety-related parameters

MTTF_D	507 years
DC_{avg}	0 %
T_M (mission time)	20 years

Electronics

Supply voltage U_B	10 V DC ... 30 V DC ¹⁾
Ripple	≤ 5 V _{pp}
Usage category	DC-12 (According to EN 60947-5-2) DC-13 (According to EN 60947-5-2)
Current consumption	≤ 30 mA, without load. At U _B = 24 V
Protection class	III
Digital output	
Number	2 (Complementary)
Type	Push-pull: PNP/NPN
Switching mode	Light/dark switching
Signal voltage PNP HIGH/LOW	Approx. U _B -2.5 V / 0 V
Signal voltage NPN HIGH/LOW	Approx. U _B / < 2.5 V
Output current I _{max.}	≤ 100 mA
Circuit protection outputs	Reverse polarity protected Overcurrent and short-circuit protected
Response time	≤ 500 μs ²⁾
Repeatability (response time)	150 μs
Switching frequency	1,000 Hz ³⁾
Time functions	Deactivated (factory setting), switch-on delay, off delay, ON and OFF delay, Impulse (one shot)
Delay time	Teach-turn adjustment, 0 ms ... 30,000 ms, 0 ms (factory setting)

¹⁾ Limit values.

²⁾ Signal transit time with resistive load in switching mode.

³⁾ With light/dark ratio 1:1.

⁴⁾ This switching output must not be connected to another output.

Pin/Wire assignment	
Function of pin 4/black (BK)	Digital output, dark switching, object present → output \bar{Q} LOW ⁴⁾
Pin 5 function/white (WH)	Digital output, light switching, object present → output Q HIGH
Pin 6 function/gray (GY)	Test after L+

¹⁾ Limit values.

²⁾ Signal transit time with resistive load in switching mode.

³⁾ With light/dark ratio 1:1.

⁴⁾ This switching output must not be connected to another output.

Mechanics

Housing	Rectangular
Dimensions (W x H x D)	24.6 mm x 82.5 mm x 53.3 mm
Connection	Cable with Q6 male connector, 6-pin, DC-coded, 298 mm
Connection detail	
Deep-freeze property	Do not bend below 0 °C
Conductor size	0.14 mm ²
Cable diameter	∅ 4.8 mm
Length of cable (L)	270 mm
Bending radius	For flexible use > 12 x cable diameter
Bending cycles	1,000,000
Material	
Housing	Plastic, VISTAL®
Front screen	Plastic, PMMA
Cable	Plastic, PVC
Male connector	Plastic, VISTAL®
Weight	Approx. 100 g
Maximum tightening torque of the fixing screws	1.3 Nm

Ambient data

Enclosure rating	IP65 (EN 60529)
Ambient operating temperature	-40 °C ... +60 °C
Ambient temperature, storage	-40 °C ... +75 °C
Shock resistance	50 g, 11 ms (25 positive and 25 negative shocks per axis, for X, Y, Z axes, 150 shocks in total (EN60068-2-27)) 50 g, 6 ms (5,000 positive and 5,000 negative shocks per axis, for X, Y, Z axes, 30,000 shocks in total (EN60068-2-27))
Vibration resistance	10 Hz ... 2,000 Hz (Amplitude 0.5 mm / 10 g, 20 sweeps per axis, for X, Y, Z axes, 1 octave/min, (EN60068-2-6))
Air humidity	35 % ... 95 %, relative humidity (no condensation)
Electromagnetic compatibility (EMC)	EN 60947-5-2
UL File No.	NRKH.E181493 & NRKH7.E181493

Certificates

EU declaration of conformity	✓
UK declaration of conformity	✓
ACMA declaration of conformity	✓

Moroccan declaration of conformity	✓
China RoHS	✓
ECOLAB certificate	✓
cULus certificate	✓
Photobiological safety (DIN EN 62471) certificate	✓

Classifications

ECLASS 5.0	27270904
ECLASS 5.1.4	27270904
ECLASS 6.0	27270904
ECLASS 6.2	27270904
ECLASS 7.0	27270904
ECLASS 8.0	27270904
ECLASS 8.1	27270904
ECLASS 9.0	27270904
ECLASS 10.0	27270904
ECLASS 11.0	27270904
ECLASS 12.0	27270903
ETIM 5.0	EC002719
ETIM 6.0	EC002719
ETIM 7.0	EC002719
ETIM 8.0	EC002719
UNSPSC 16.0901	39121528



Dimensional drawing, sensor

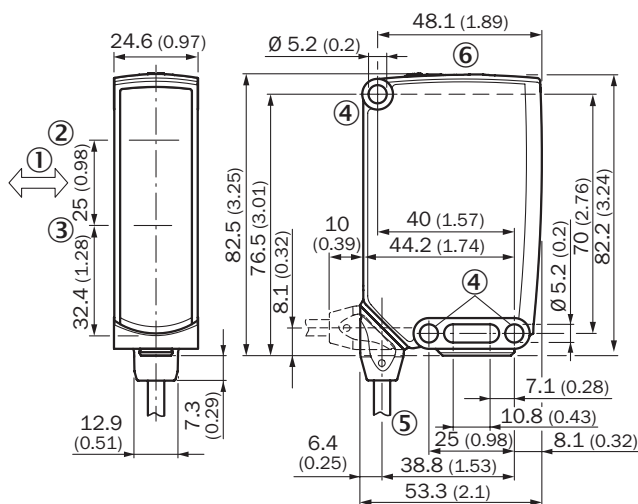

Dimensions in mm (inch)

- ① Standard direction of the material being detected
- ② Center of optical axis, sender
- ③ Center of optical axis, receiver

- ④ Mounting hole, Ø 5.2 mm
- ⑤ Connection
- ⑥ display and adjustment elements

display and adjustment elements

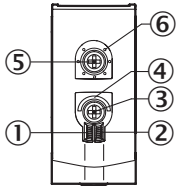

- ① LED indicator green
- ② LED indicator yellow
- ③ Teach-Turn adjustment 1
- ④ LED blue 1
- ⑤ Teach-Turn adjustment 2
- ⑥ LED blue 2

Connection type Cubic connector, 6-pin

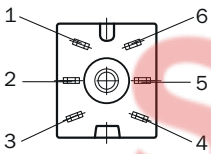

Connection diagram Cd-427

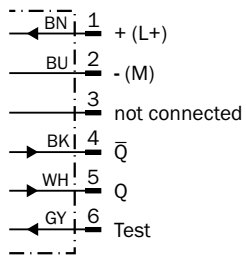

Truth table Push-pull: PNP/NPN - light switching Q

	Light switching Q (normally open (upper switch), normally closed (lower switch))	
	Object not present → Output LOW	Object present → Output HIGH
Light receive	✗	✓
Light receive indicator	✗	☀
Load resistance to L+	⚡	✗
Load resistance to M	✗	⚡

Truth table Push-pull: PNP/NPN - dark switching \bar{Q}

	Dark switching \bar{Q} (normally closed (upper switch), normally open (lower switch))	
	Object not present → Output HIGH	Object present → Output LOW
Light receive	✗	✓
Light receive indicator	✗	☀
Load resistance to L+	✗	⚡
Load resistance to M	⚡	✗

Characteristic curve WTB26I-xxxx1xx

Minimum distance in mm (y) between the set sensing range and white background (90 % remission)

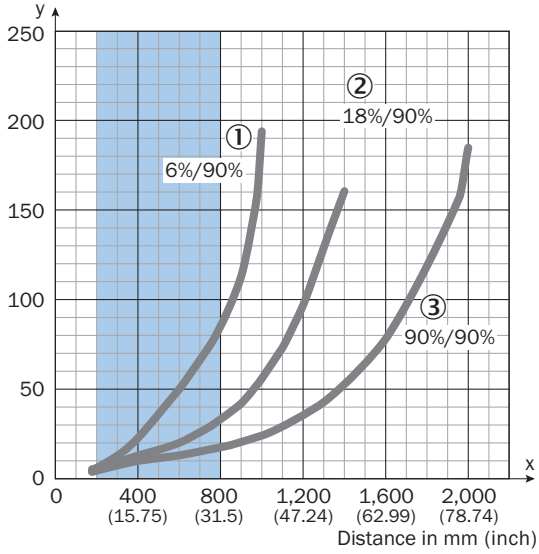

Example:
Safe suppression of the background

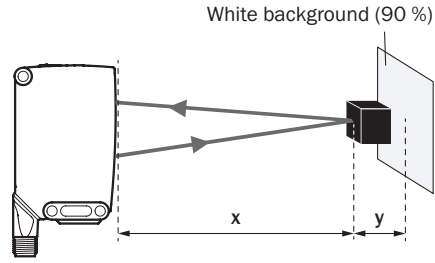

Black object (6 % remission)
Set sensing range x = 800 mm
Needed minimum distance to white background y = 85 mm

Recommended sensing range for the best performance

- ① Black object, 6% remission factor
- ② Gray object, 18% remission factor
- ③ White object, 90% remission factor



Light spot size WTB26I-xxxx1xx

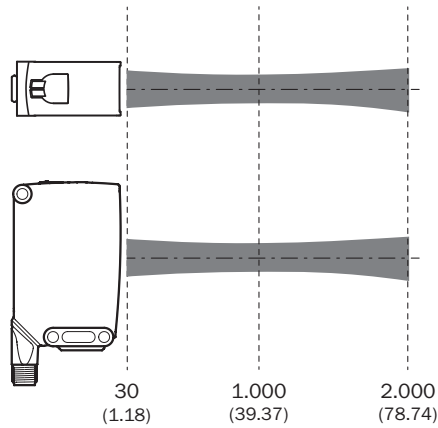
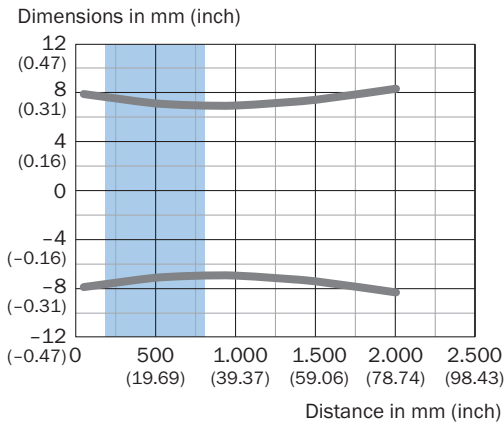

Recommended sensing range for the best performance

Sensing range diagram

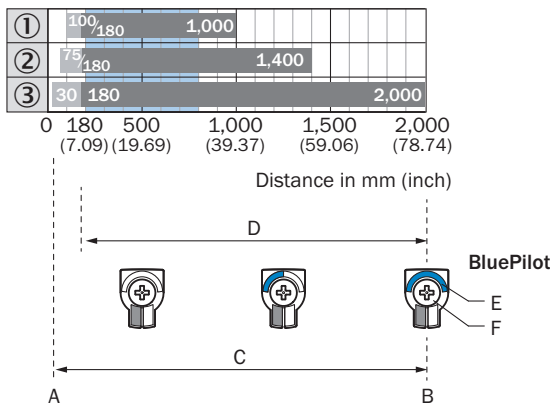





Recommended sensing range for the best performance

1	Black object, 6% remission factor
2	Gray object, 18% remission factor
3	White object, 90% remission factor
A	Sensing range min. in mm
B	Sensing range max. in mm
C	Field of view
D	Adjustable switching threshold for background suppression
E	Sensing range indicator
F	Teach-Turn adjustment

Recommended accessories

Other models and accessories → www.sick.com/W26

	Brief description	Type	part no.
connectors and cables			
	<ul style="list-style-type: none"> • Connection type head A: Female connector, 6-pin, angled, DC-coded • Connection type head B: Flying leads • Signal type: Sensor/actuator cable • Cable: 2 m, PVC • Description: Sensor/actuator cable, unshielded 	DOL-1306-W02M	6030217

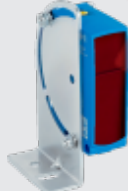
	Brief description	Type	part no.
Mounting systems			
	<ul style="list-style-type: none"> • Description: Mounting bracket with hinged arm • Material: Steel • Details: Steel, zinc coated • Items supplied: Mounting hardware included • Suitable for: W23-2, W27-3, Reflex Array 	BEF-WN-W27	2009122
	<ul style="list-style-type: none"> • Description: Plate N12 for universal clamp. For mounting PL30A, P250 reflectors, W27 and WTR2 sensors. • Material: Steel, zinc diecast • Details: Zinc plated steel (sheet), Zinc die cast (clamping bracket) • Items supplied: Universal clamp (2022726), mounting hardware • Usable for: W26, Reflex Array, P250, W23-2, W27-3, W27-3 	BEF-KHS-N12	2071950
	<ul style="list-style-type: none"> • Description: Mounting bracket with articulated arm • Material: Steel • Details: Steel, zinc coated • Items supplied: Mounting hardware included • Suitable for: W16, W26, W11, W12, W23, W27, Dx50, W280, G10 	BEF-WN-MULTI2	2093945
	<ul style="list-style-type: none"> • Description: Mounting bracket • Material: Steel • Details: Steel, zinc coated • Items supplied: Mounting hardware included • Suitable for: W23-2, W27-3, Reflex Array 	BEF-WN-W23	2019085

SICK AT A GLANCE

SICK is one of the leading manufacturers of intelligent sensors and sensor solutions for industrial applications. A unique range of products and services creates the perfect basis for controlling processes securely and efficiently, protecting individuals from accidents and preventing damage to the environment.

We have extensive experience in a wide range of industries and understand their processes and requirements. With intelligent sensors, we can deliver exactly what our customers need. In application centers in Europe, Asia and North America, system solutions are tested and optimized in accordance with customer specifications. All this makes us a reliable supplier and development partner.

Comprehensive services complete our offering: SICK LifeTime Services provide support throughout the machine life cycle and ensure safety and productivity.

For us, that is “Sensor Intelligence.”

WORLDWIDE PRESENCE:

Contacts and other locations – www.sick.com

SpareCruX