



# MPS-200CLTQ0

MPS-C

CYLINDER SENSORS

**SICK**  
Sensor Intelligence.



### Ordering information

Type	part no.
MPS-200CLTQ0	1111086

Other models and accessories → [www.sick.com/MPS-C](http://www.sick.com/MPS-C)



### Detailed technical data

#### Features

<b>Cylinder type</b>	C-slot
<b>Cylinder types with adapter</b>	Round body cylinder Profile cylinders and tie-rod cylinders SMC rail CDQ2 SMC rail ECDQ2
<b>Measuring range</b>	200 mm <sup>1)</sup>
<b>Housing length</b>	215 mm
<b>Switching output</b>	Push-pull: PNP/NPN
<b>Output function</b>	Analog, IO-Link
<b>Electrical wiring</b>	DC 4-wire
<b>Analog output (voltage)</b>	0 V ... 10 V
<b>Analog output (current)</b>	4 mA ... 20 mA
<b>Enclosure rating</b>	IP67 <sup>2)</sup>
<b>Adjustment</b>	
Teach-in control panel	Teaching in analog outputs Selecting the current/voltage output Inverting the analog output Teaching in digital switching outputs
IO-Link	Teaching in 4 switching points Pin 2 configuration (0 V–10 V, 4 mA–20 mA) Measuring range (mm) teach-in (analog output) Disabling teach-in pushbutton Teach-in modes per output via IO-Link (cylinder switch mode, two point mode, window mode, and single point mode)

<sup>1)</sup> ± 1 mm.

<sup>2)</sup> According to EN 60529.

Mechanics/electronics

<b>Supply voltage</b>	12 V DC ... 30 V DC
<b>Power consumption</b>	42 mA, without load
<b>Voltage drop</b>	≤ 2 V
<b>Continuous current I<sub>a</sub></b>	≤ 100 mA <sup>1)</sup>
<b>Max. load resistance</b>	≤ 500 Ω Power Output, at 24 V
<b>Min. load resistance</b>	≥ 2 kΩ <sup>2)</sup>
<b>Protection class</b>	III
<b>Time delay before availability</b>	0.15 s
<b>Required magnetic field sensitivity, typ.</b>	3 mT ... 12 mT
<b>Resolution, typ.</b>	≥ 50 μm
<b>Linearity error, typ.</b>	0.3 mm <sup>3)</sup>
<b>Repeat accuracy, typ.</b>	0.1 mm <sup>4)</sup>
<b>Sampling rate, typ.</b>	1 ms
<b>Reverse polarity protection</b>	Yes
<b>Short-circuit protection</b>	Yes
<b>Status indicator LED</b>	Yes
<b>Digital switching output</b>	Yes
<b>Teach-in</b>	Yes
<b>Ambient operating temperature</b>	-20 °C ... +70 °C
<b>Shock and vibration resistance</b>	30 g, 11 ms / 10 ... 55 Hz, 1 mm
<b>EMC</b>	According to EN 60947-5-7 <sup>5)</sup>
<b>Connection type</b>	Cable with connector M12, 4-pin, with knurled nut, 0.3 m
<b>Connection type Detail</b>	
Deep-freeze property	Do not bend below 0 °C
Conductor cross section	0.08 mm <sup>2</sup>
Cable diameter	Ø 2.6 mm
Bending radius	With fixed installation > 5 x cable diameter
	For flexible use > 10 x cable diameter
Cable outlet	Axial
<b>Material</b>	
Housing	Plastic
Cable	PUR
<b>UL File No.</b>	NRKH.E181493 & NRKH7.E181493

<sup>1)</sup> ≤ 100 mA (PUSH); ≥ -100 mA (PULL).

<sup>2)</sup> Voltage output.

<sup>3)</sup> At 25 °C, linearity error (maximum deviation) depending on response curve and minimal deviation function.

<sup>4)</sup> At 25 °C, repeatability magnet movement in one direction.

<sup>5)</sup> The analog measured value can deviate under transient conditions.

Safety-related parameters

<b>MTTF<sub>D</sub></b>	72 years
<b>DC<sub>avg</sub></b>	0 %

<b>T<sub>M</sub> (mission time)</b>	20 years
-------------------------------------	----------

### Communication interface

<b>Communication interface</b>	IO-Link V1.1
<b>Communication Interface detail</b>	COM3
<b>Cycle time</b>	1 ms
<b>Process data length</b>	16 Bit
<b>Process data structure</b>	Bit 0 = switching signal Q <sub>L1</sub> Bit 1 = switching signal Q <sub>L2</sub> Bit 2 = switching signal Q <sub>L3</sub> Bit 3 = switching signal Q <sub>L4</sub> Bit 4 ... 15 = position (in 50 µm)

### Certificates

<b>EU declaration of conformity</b>	✓
<b>UK declaration of conformity</b>	✓
<b>ACMA declaration of conformity</b>	✓
<b>China RoHS</b>	✓
<b>cULus certificate</b>	✓
<b>IO-Link certificate</b>	✓
<b>Information according to Art. 3 of Data Act (Regulation EU 2023/2854)</b>	✓

### Classifications

<b>ECLASS 5.0</b>	27270104
<b>ECLASS 5.1.4</b>	27270104
<b>ECLASS 6.0</b>	27270104
<b>ECLASS 6.2</b>	27270104
<b>ECLASS 7.0</b>	27270104
<b>ECLASS 8.0</b>	27270104
<b>ECLASS 8.1</b>	27270104
<b>ECLASS 9.0</b>	27270104
<b>ECLASS 10.0</b>	27270104
<b>ECLASS 11.0</b>	27270104
<b>ECLASS 12.0</b>	27274301
<b>ETIM 5.0</b>	EC002544
<b>ETIM 6.0</b>	EC002544
<b>ETIM 7.0</b>	EC002544
<b>ETIM 8.0</b>	EC002544
<b>UNSPSC 16.0901</b>	39122230

Installation note

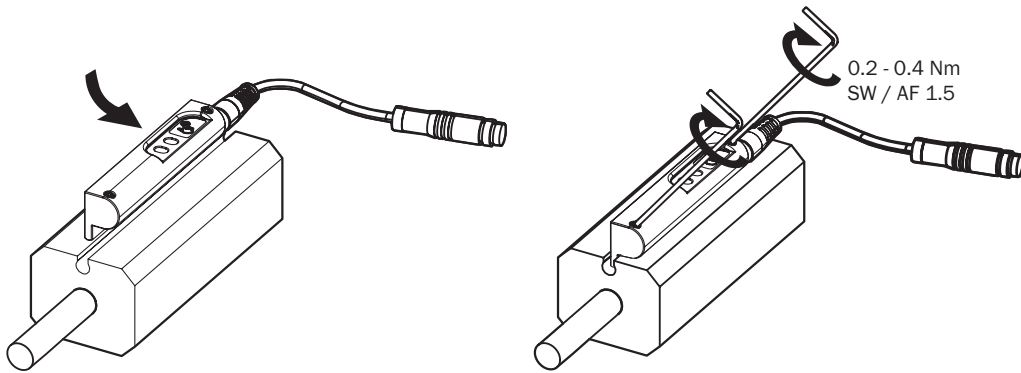

Connection diagram Cd-357

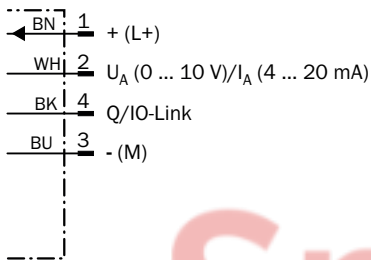

Dimensional drawing Cable with M12 male connector

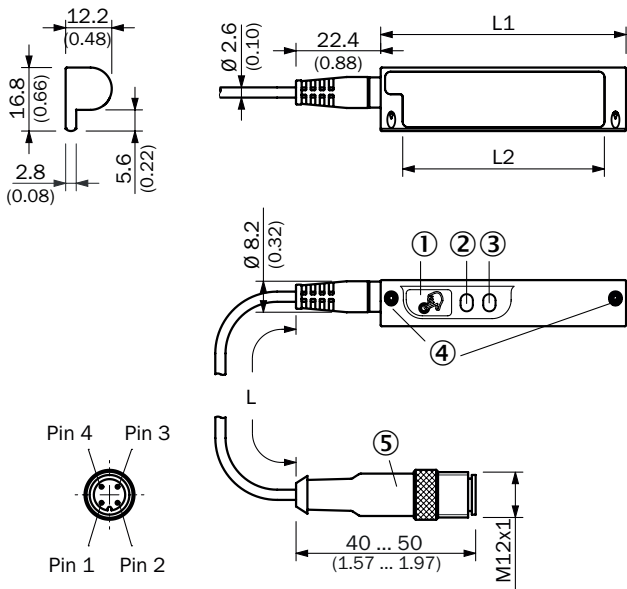

	Total length (L1) mm	Measuring range (L2) mm
<b>MPS-xxx</b>	40.6	25
<b>MPS-xxx</b>	64.9	50
<b>MPS-xxx</b>	114.9	100
<b>MPS-xxx</b>	214.7	200

Dimensions in mm (inch)





- ① Teach-in button
- ② status LEDs
- ③ operating LEDs
- ④ Fixing screw SW 1.5

⑤ Connection

Part no.	Type	L	Number of cores
1127298	MPS-100CLTQO	300 mm	4
1111086	MPS-200CLTQO	300 mm	4
1111002	MPS-025CLTQDS01	600 mm	4

Recommended accessories

Other models and accessories → [www.sick.com/MPS-C](http://www.sick.com/MPS-C)

	Brief description	Type	part no.
<b>Mounting systems</b>			
	<ul style="list-style-type: none"> <li><b>Description:</b> Mounting bracket for integrated profile cylinder/tie-rod cylinder</li> <li><b>Material:</b> Zinc diecast</li> <li><b>Details:</b> Zinc diecast</li> <li><b>Items supplied:</b> Mounting hardware included</li> </ul>	BEF-KHZ-PC1	2076170
	<ul style="list-style-type: none"> <li><b>Description:</b> Mounting bracket on round body cylinder with piston diameter of 1 mm ... 130 mm, ambient temperature min -30 °C max 80 °C</li> <li><b>Material:</b> Stainless steel, Aluminum</li> <li><b>Details:</b> Stainless steel, Aluminum</li> <li><b>Packing unit:</b> 1 piece</li> <li><b>Suitable for:</b> C-slot</li> </ul>	BEF-KHZ-RC1-130	2077686
	<ul style="list-style-type: none"> <li><b>Description:</b> Mounting bracket on round body cylinder with piston diameter of 1 mm ... 25 mm, ambient temperature min -30 °C max 80 °C</li> <li><b>Material:</b> Stainless steel, Aluminum</li> <li><b>Details:</b> Stainless steel, Aluminum</li> <li><b>Packing unit:</b> 1 piece</li> <li><b>Suitable for:</b> C-slot</li> </ul>	BEF-KHZ-RC1-25	2077685
	<ul style="list-style-type: none"> <li><b>Description:</b> Label Holder, 2.5 mm to 3.5 mm, 10 pcs.</li> <li><b>Material:</b> Plastic</li> <li><b>Details:</b> TPU</li> <li><b>Packing unit:</b> 10 pieces</li> </ul>	LABEL HOLDER	2086019
<b>connectors and cables</b>			
	<ul style="list-style-type: none"> <li><b>Connection type head A:</b> Female connector, M12, 4-pin, straight, A-coded</li> <li><b>Connection type head B:</b> Male connector, M8, 4-pin, straight, A-coded</li> <li><b>Signal type:</b> Sensor/actuator cable</li> <li><b>Cable:</b> 0.6 m, 4-wire, PUR, halogen-free</li> <li><b>Description:</b> Sensor/actuator cable, unshielded</li> <li><b>Application:</b> Uncontaminated zones, Zones with oils and lubricants, Robot, Drag chain operation</li> </ul>	YF2A14-C60UA3M8U14	2096111
	<ul style="list-style-type: none"> <li><b>Connection type head A:</b> Female connector, M12, 4-pin, straight, A-coded</li> <li><b>Connection type head B:</b> Male connector, M8, 4-pin, straight, A-coded</li> <li><b>Signal type:</b> Sensor/actuator cable</li> <li><b>Cable:</b> 3 m, 4-wire, PUR, halogen-free</li> <li><b>Description:</b> Sensor/actuator cable, unshielded</li> <li><b>Application:</b> Uncontaminated zones, Zones with oils and lubricants, Robot, Drag chain operation</li> </ul>	YF2A14-030UA3M8U14	2145634
	<ul style="list-style-type: none"> <li><b>Connection type head A:</b> Female connector, M12, 4-pin, straight, A-coded</li> <li><b>Connection type head B:</b> Male connector, M8, 4-pin, straight, A-coded</li> <li><b>Signal type:</b> Sensor/actuator cable</li> <li><b>Cable:</b> 10 m, 4-wire, PUR, halogen-free</li> <li><b>Description:</b> Sensor/actuator cable, unshielded</li> <li><b>Application:</b> Uncontaminated zones, Zones with oils and lubricants, Robot, Drag chain operation</li> </ul>	YF2A14-100UA3M8U14	2145633
	<ul style="list-style-type: none"> <li><b>Connection type head A:</b> Female connector, M12, 4-pin, straight, A-coded</li> <li><b>Connection type head B:</b> Male connector, M12, 4-pin, straight, A-coded</li> <li><b>Signal type:</b> Sensor/actuator cable</li> <li><b>Cable:</b> 1 m, 4-wire, PVC</li> <li><b>Description:</b> Sensor/actuator cable, unshielded</li> <li><b>Application:</b> Zones with chemicals, Uncontaminated zones</li> </ul>	YF2A14-010VB3M2A14	2110005

## SICK AT A GLANCE

SICK is one of the leading manufacturers of intelligent sensors and sensor solutions for industrial applications. A unique range of products and services creates the perfect basis for controlling processes securely and efficiently, protecting individuals from accidents and preventing damage to the environment.

We have extensive experience in a wide range of industries and understand their processes and requirements. With intelligent sensors, we can deliver exactly what our customers need. In application centers in Europe, Asia and North America, system solutions are tested and optimized in accordance with customer specifications. All this makes us a reliable supplier and development partner.

Comprehensive services complete our offering: SICK LifeTime Services provide support throughout the machine life cycle and ensure safety and productivity.

For us, that is “Sensor Intelligence.”

### WORLDWIDE PRESENCE:

Contacts and other locations – [www.sick.com](http://www.sick.com)

SpareCruX