



# IMX18-30NPSZU2S

IMX

INDUCTIVE PROXIMITY SENSORS

**SICK**  
Sensor Intelligence.



### Ordering information

Type	part no.
IMX18-30NPSZU2S	1107448

**Included in delivery:** BEF-MU-M18 (1)

Other models and accessories → [www.sick.com/IMX](http://www.sick.com/IMX)

Illustration may differ



### Detailed technical data

#### Features

<b>Housing</b>	Metric
<b>Housing</b>	Standard design
<b>Thread size</b>	M18 x 1
<b>Diameter</b>	Ø 18 mm
<b>Sensing range <math>S_n</math></b>	30 mm
<b>Safe sensing range <math>S_a</math></b>	24.3 mm
<b>Installation type</b>	Non-flush
<b>Switching frequency</b>	10 Hz
<b>Connection type</b>	Cable, 3-wire, 2 m
<b>Switching output</b>	PNP
<b>Switching output detail</b>	PNP
<b>Output function</b>	NO
<b>Electrical wiring</b>	DC 3-wire
<b>Enclosure rating</b>	IP68 <sup>1)</sup>
<b>Special features</b>	Quadruple sensing range, Resistant against coolant lubricants, Visual adjustment indicator
<b>Special applications</b>	Zones with coolants and lubricants
<b>Items supplied</b>	Mounting nut, brass, nickel-plated (2x)

<sup>1)</sup> According to EN 60529.

#### Mechanics/electronics

<b>Supply voltage</b>	10 V DC ... 30 V DC
<b>Ripple</b>	≤ 10 %
<b>Voltage drop</b>	≤ 2 V <sup>1)</sup>
<b>Time delay before availability</b>	≤ 150 ms

<sup>1)</sup> At  $I_a$  max.

<sup>2)</sup> Supply voltage  $U_B$  and constant ambient temperature  $T_a$ .

<sup>3)</sup> Of  $S_r$ .

<b>Hysteresis</b>	5 % ... 15 %
<b>Reproducibility</b>	≤ 7 % <sup>2)</sup> <sup>3)</sup>
<b>Temperature drift (of S<sub>r</sub>)</b>	± 10 %
<b>EMC</b>	According to EN 60947-5-2
<b>Continuous current I<sub>a</sub></b>	≤ 200 mA
<b>No load current</b>	≤ 50 mA
<b>Cable material</b>	PUR
<b>Conductor size</b>	0.34 mm <sup>2</sup>
<b>Cable diameter</b>	Ø 4.5 mm
<b>Short-circuit protection</b>	✓
<b>Power-up pulse protection</b>	✓
<b>Shock and vibration resistance</b>	30 g, 11 ms / 10 ... 55 Hz, 1 mm
<b>Display</b>	
	LED yellow Output state (on/off)
	LED green Stable on/off state
<b>Ambient operating temperature</b>	-25 °C ... +75 °C
<b>Housing material</b>	Nickel-plated brass
<b>Sensing face material</b>	Plastic, LCP
<b>Housing length</b>	59 mm
<b>Thread length</b>	46.5 mm
<b>Tightening torque, max.</b>	≤ 30 Nm
<b>Protection class</b>	III
<b>UL File No.</b>	E181493
<b>Service interface</b>	IO-Link as a service interface. The interface can only be used by SICK Service.

<sup>1)</sup> At I<sub>a</sub> max.

<sup>2)</sup> Supply voltage U<sub>B</sub> and constant ambient temperature T<sub>a</sub>.

<sup>3)</sup> Of S<sub>r</sub>.

### Safety-related parameters

<b>MTTF<sub>D</sub></b>	411 years
<b>DC<sub>avg</sub></b>	0 %
<b>T<sub>M</sub> (mission time)</b>	20 years

### Reduction factors

<b>Note</b>	The values are reference values which may vary
<b>St37 steel (Fe)</b>	1
<b>Stainless steel (V2A, 304)</b>	1
<b>Aluminum (Al)</b>	0.6
<b>Copper (Cu)</b>	0.4
<b>Brass (Br)</b>	0.7

### Installation note

<b>Remark</b>	Associated graphic see "Installation"
---------------	---------------------------------------

<b>A</b>	56 mm
<b>B</b>	36 mm
<b>C</b>	18 mm
<b>D</b>	90 mm
<b>E</b>	35 mm
<b>F</b>	90 mm

Certificates

<b>EU declaration of conformity</b>	✓
<b>UK declaration of conformity</b>	✓
<b>ACMA declaration of conformity</b>	✓
<b>Moroccan declaration of conformity</b>	✓
<b>China RoHS</b>	✓
<b>cULus certificate</b>	✓
<b>Information according to Art. 3 of Data Act (Regulation EU 2023/2854)</b>	✓

Classifications

<b>ECLASS 5.0</b>	27270101
<b>ECLASS 5.1.4</b>	27270101
<b>ECLASS 6.0</b>	27270101
<b>ECLASS 6.2</b>	27270101
<b>ECLASS 7.0</b>	27270101
<b>ECLASS 8.0</b>	27270101
<b>ECLASS 8.1</b>	27270101
<b>ECLASS 9.0</b>	27270101
<b>ECLASS 10.0</b>	27270101
<b>ECLASS 11.0</b>	27270101
<b>ECLASS 12.0</b>	27274001
<b>ETIM 5.0</b>	EC002714
<b>ETIM 6.0</b>	EC002714
<b>ETIM 7.0</b>	EC002714
<b>ETIM 8.0</b>	EC002714
<b>UNSPSC 16.0901</b>	39122230

Installation note Non-flush installation



Connection diagram Cd-001

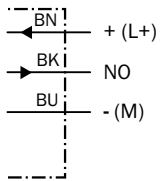

Response diagram

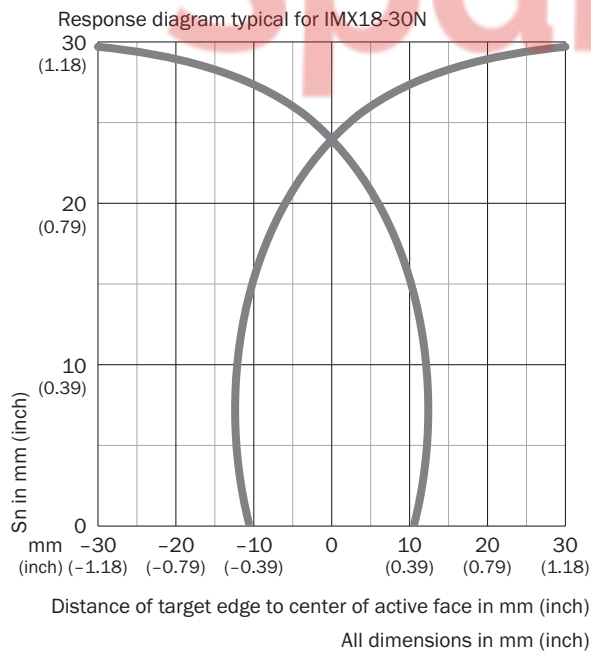

Functional principle Installation aid

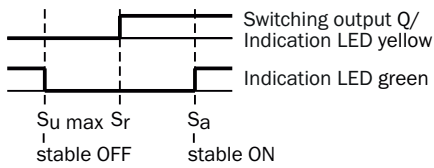

LED indicator green	LED indicator yellow	Status
ON	OFF	Output is deactivated (OFF), sensor in stable OFF state
OFF	OFF	Output is deactivated (OFF), no object detected
OFF	ON	Output is activated (ON), object detected
ON	ON	Output is activated (ON), sensor in stable ON state

Dimensional drawing IMX18, standard variant, cable, non-flush

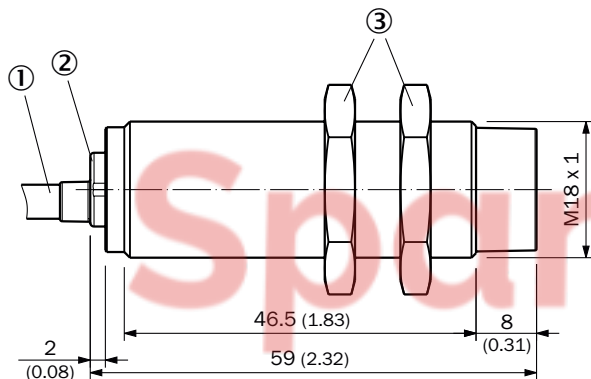





Dimensions in mm (inch)

- ① Connection
- ② Display LED
- ③ fastening nuts (2x); width across 24, brass nickel-plated

Recommended accessories

Other models and accessories → [www.sick.com/IMX](http://www.sick.com/IMX)

	Brief description	Type	part no.
<b>Mounting systems</b>			
	<ul style="list-style-type: none"> <li>• <b>Description:</b> Mounting bracket for M18 sensors</li> <li>• <b>Material:</b> Stainless steel</li> <li>• <b>Details:</b> Stainless steel</li> <li>• <b>Items supplied:</b> Without mounting hardware</li> </ul>	BEF-WN-M18N	5320947
	<ul style="list-style-type: none"> <li>• <b>Description:</b> Mounting bracket for M18 sensors</li> <li>• <b>Material:</b> Steel</li> <li>• <b>Details:</b> Steel, zinc coated</li> <li>• <b>Items supplied:</b> Without mounting hardware</li> <li>• <b>Suitable for:</b> GR18, V180-2, V18, W15, Z1, Z2</li> </ul>	BEF-WN-M18	5308446

	Brief description	Type	part no.
connectors and cables			
	<ul style="list-style-type: none"> <li>• <b>Connection type head A:</b> Male connector, M12, 4-pin, straight, A-coded</li> <li>• <b>Description:</b> Unshielded</li> <li>• <b>Connection systems:</b> Screw-type terminals</li> <li>• <b>Permitted cross-section:</b> ≤ 0.75 mm<sup>2</sup></li> <li>• <b>Application:</b> Hygienic and washdown zones</li> </ul>	STE-1204-GN	6028359
	<ul style="list-style-type: none"> <li>• <b>Connection type head A:</b> Female connector, M12, 4-pin, straight, A-coded</li> <li>• <b>Description:</b> Unshielded</li> <li>• <b>Connection systems:</b> Screw-type terminals</li> <li>• <b>Permitted cross-section:</b> ≤ 0.75 mm<sup>2</sup></li> <li>• <b>Application:</b> Hygienic and washdown zones</li> </ul>	DOS-1204-GN	6028357
	<ul style="list-style-type: none"> <li>• <b>Connection type head A:</b> Female connector, M12, 4-pin, angled, A-coded</li> <li>• <b>Description:</b> Unshielded</li> <li>• <b>Connection systems:</b> Screw-type terminals</li> <li>• <b>Permitted cross-section:</b> ≤ 0.75 mm<sup>2</sup></li> <li>• <b>Application:</b> Hygienic and washdown zones</li> </ul>	DOS-1204-WN	6028358

SpareCruX

## SICK AT A GLANCE

SICK is one of the leading manufacturers of intelligent sensors and sensor solutions for industrial applications. A unique range of products and services creates the perfect basis for controlling processes securely and efficiently, protecting individuals from accidents and preventing damage to the environment.

We have extensive experience in a wide range of industries and understand their processes and requirements. With intelligent sensors, we can deliver exactly what our customers need. In application centers in Europe, Asia and North America, system solutions are tested and optimized in accordance with customer specifications. All this makes us a reliable supplier and development partner.

Comprehensive services complete our offering: SICK LifeTime Services provide support throughout the machine life cycle and ensure safety and productivity.

For us, that is “Sensor Intelligence.”

### WORLDWIDE PRESENCE:

Contacts and other locations – [www.sick.com](http://www.sick.com)

SpareCruX