



IHM03-0B6PSVU2S

IMM

INDUCTIVE PROXIMITY SENSORS

SICK
Sensor Intelligence.



Ordering information

| Type | part no. |
|-----------------|----------|
| IHM03-0B6PSVU2S | 1102476 |

Other models and accessories → www.sick.com/IMM

Illustration may differ



Detailed technical data

Features

| | |
|--|--------------------------------|
| Housing | Cylindrical |
| Housing | Standard design |
| Diameter | Ø 3 mm |
| Sensing range S_n | 0.6 mm |
| Safe sensing range S_a | 0.486 mm |
| Installation type | Flush |
| Switching frequency | 5,000 Hz |
| Connection type | Cable, 3-wire, 2 m |
| Switching output | PNP |
| Switching output detail | PNP |
| Output function | NO |
| Electrical wiring | DC 3-wire |
| Enclosure rating | IP67 ¹⁾ |
| Special features | Visual adjustment indicator |
| Items supplied | Cable flag, Polymatic 50 (1 x) |

¹⁾ According to EN 60529.

Mechanics/electronics

| | |
|---------------------------------------|----------------------|
| Supply voltage | 10 V DC ... 30 V DC |
| Ripple | ≤ 20 % ¹⁾ |
| Voltage drop | ≤ 2 V ²⁾ |
| Time delay before availability | ≤ 10 ms |

¹⁾ Of V_S .

²⁾ With $I_a = 200$ mA.

³⁾ Supply voltage U_B and constant ambient temperature T_a .

| | |
|---|--|
| Hysteresis | 1 % ... 15 % |
| Reproducibility | ≤ 2.5 % ³⁾ |
| Temperature drift (of S_r) | ≤ 10 % |
| EMC | EN 60947-5-2 |
| Continuous current I_a | ≤ 100 mA |
| Cable material | PUR |
| Conductor size | 0.08 mm ² |
| Cable diameter | Ø 2.5 mm |
| Short-circuit protection | ✓ |
| Power-up pulse protection | ✓ |
| Shock and vibration resistance | 30 g, 11 ms / 10 ... 55 Hz, 1 mm |
| Ambient operating temperature | -25 °C ... +70 °C |
| Housing material | Stainless steel V2A, DIN 1.4305 / AISI 303 |
| Sensing face material | Plastic, LCP |
| Housing length | 22 mm |
| UL File No. | NRKH.E348498 |

¹⁾ Of V_S.

²⁾ With I_a = 200 mA.

³⁾ Supply voltage U_B and constant ambient temperature T_a.

Safety-related parameters

| | |
|-------------------------|-------------|
| MTTF_D | 1,638 years |
| DC_{avg} | 0 % |

Communication interface

| | |
|---------------------------------------|--|
| Communication interface | IO-Link V1.1 |
| Communication Interface detail | COM2 (38,4 kBaud) |
| Cycle time | 10.4 ms |
| Process data length | 1 Byte |
| Process data structure | Bit 0 = Sr reached Bit 1 = Sa reached |

Reduction factors

| | |
|-----------------------------------|--|
| Note | The values are reference values which may vary |
| St37 steel (Fe) | 1 |
| Stainless steel (V2A, 304) | Approx. 0.75 |
| Aluminum (Al) | Approx. 0.54 |
| Copper (Cu) | Approx. 0.39 |
| Brass (Br) | Approx. 0.63 |

Installation note

| | |
|---------------|---------------------------------------|
| Remark | Associated graphic see "Installation" |
| B | 2.5 mm |
| C | 3 mm |
| D | 1.8 mm |

| | |
|----------|------|
| F | 5 mm |
|----------|------|

Certificates

| | |
|---|---|
| EU declaration of conformity | ✓ |
| UK declaration of conformity | ✓ |
| ACMA declaration of conformity | ✓ |
| Moroccan declaration of conformity | ✓ |
| IO-Link certificate | ✓ |

Classifications

| | |
|-----------------------|----------|
| ECLASS 5.0 | 27270101 |
| ECLASS 5.1.4 | 27270101 |
| ECLASS 6.0 | 27270101 |
| ECLASS 6.2 | 27270101 |
| ECLASS 7.0 | 27270101 |
| ECLASS 8.0 | 27270101 |
| ECLASS 8.1 | 27270101 |
| ECLASS 9.0 | 27270101 |
| ECLASS 10.0 | 27270101 |
| ECLASS 11.0 | 27270101 |
| ECLASS 12.0 | 27274001 |
| ETIM 5.0 | EC002714 |
| ETIM 6.0 | EC002714 |
| ETIM 7.0 | EC002714 |
| ETIM 8.0 | EC002714 |
| UNSPSC 16.0901 | 39122230 |

Installation note Mounting using BEF-KH-M03 bracket

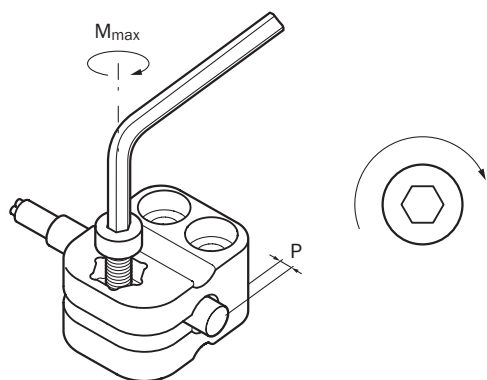

| Sensor type | Mounting adapter | Overrun (P) | Max. tightening torque (M_{max}) |
|----------------------------------|------------------------------|-----------------------------|--------------------------------------|
| IHM03-0B6***** IHM03-01B***** | BEF-KH-M03, part no. 2101064 | 0 mm ... 2 mm / ≥ 2 mm | ≤ 0.4 Nm / ≤ 0.6 Nm |

Installation note Fixing with setscrew

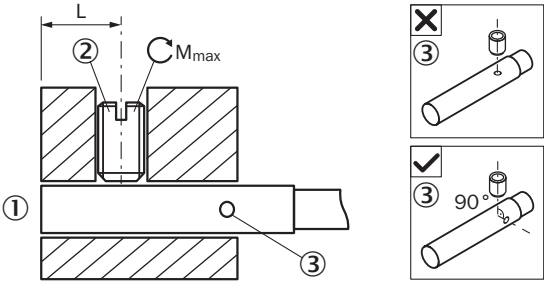

- ① Sensing face
- ② Recommended setscrew: M3, flat point
- ③ Display LED

| Sensor type | Mounting area (L) | Max. tightening torque (M _{max}) |
|------------------------------------|-------------------|--|
| IHM03-01B*****K | 5.5 mm ... 9 mm | ≤ 0.2 Nm |
| IHM03-0B6*****S IHM03-01B*****S | 5.5 mm ... 19 mm | ≤ 0.2 Nm |

Installation note Flush installation

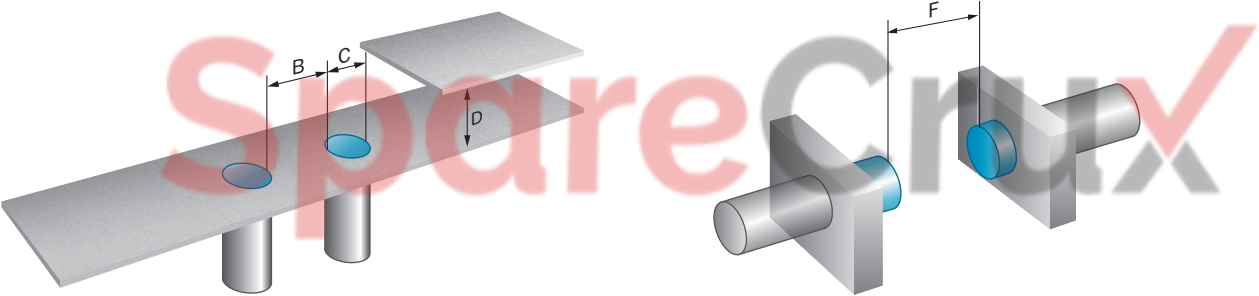

Connection diagram Cd-001

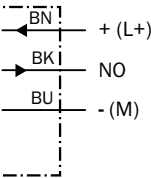

Response diagram

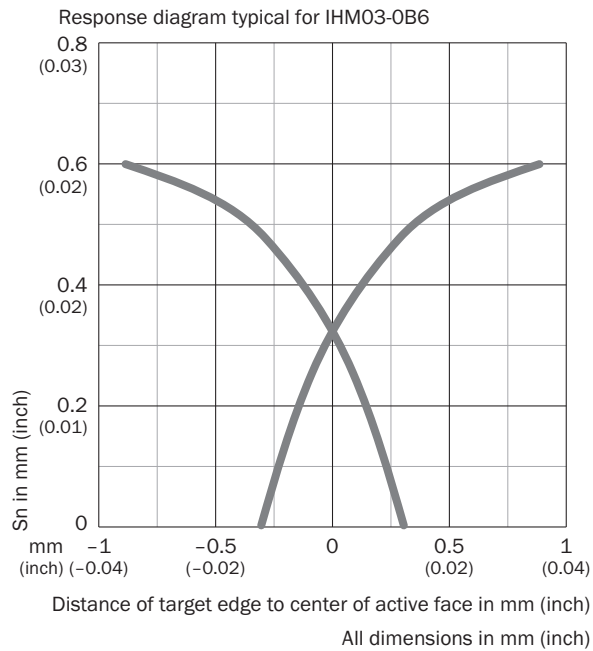

Functional principle Installation aid

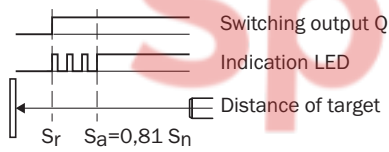



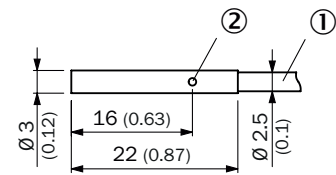

Dimensional drawing IHM03, standard variant, flush, cable



- ① Connection
- ② function indicator

Recommended accessories

Other models and accessories → www.sick.com/IMM

| | Brief description | Type | part no. |
|--|--|--------------------|----------|
| Mounting systems | | | |
|  | <ul style="list-style-type: none"> Material: Plastic Details: Plastic (PA6) Items supplied: Without mounting hardware Usable for: Round sensors with 3 mm housing diameter without fixed stop | BEF-KH-M03 | 2101064 |
| connectors and cables | | | |
|  | <ul style="list-style-type: none"> Number of slots: 4 Slot connection type: M8, 3-pin, A-coded, female connector Items supplied: 5 x labeling plates Description: Unshielded | Y8A34A2-C2A8000XXX | 2115733 |
|  | <ul style="list-style-type: none"> Number of slots: 4 Slot connection type: M8, 3-pin, A-coded, female connector Items supplied: 5 x labeling plates Cable: 5 m, 6-wire, PUR, halogen-free Description: Unshielded Application: Drag chain operation | Y8A34A2-LXXXUAA050 | 2115727 |
|  | <ul style="list-style-type: none"> Number of slots: 6 Slot connection type: M8, 3-pin, A-coded, female connector Items supplied: 5 x labeling plates Description: Unshielded | Y8A36A2-C2A8000XXX | 2115734 |
|  | <ul style="list-style-type: none"> Number of slots: 6 Slot connection type: M8, 3-pin, A-coded, female connector Items supplied: 5 x labeling plates Cable: 5 m, 8-wire, PUR, halogen-free Description: Unshielded Application: Drag chain operation | Y8A36A2-LXXXUBA050 | 2115728 |

SICK AT A GLANCE

SICK is one of the leading manufacturers of intelligent sensors and sensor solutions for industrial applications. A unique range of products and services creates the perfect basis for controlling processes securely and efficiently, protecting individuals from accidents and preventing damage to the environment.

We have extensive experience in a wide range of industries and understand their processes and requirements. With intelligent sensors, we can deliver exactly what our customers need. In application centers in Europe, Asia and North America, system solutions are tested and optimized in accordance with customer specifications. All this makes us a reliable supplier and development partner.

Comprehensive services complete our offering: SICK LifeTime Services provide support throughout the machine life cycle and ensure safety and productivity.

For us, that is “Sensor Intelligence.”

WORLDWIDE PRESENCE:

Contacts and other locations – www.sick.com

SpareCruX