

WTT12L-A2523

WTT12 PowerProx

TIME-OF-FLIGHT SENSORS

SICK
Sensor Intelligence.



Illustration may differ



Ordering information

Type	part no.
WTT12L-A2523	1082477

Other models and accessories → www.sick.com/WTT12_PowerProx

Detailed technical data

Features

Functional principle	Photoelectric proximity sensor
Functional principle detail	Background suppression, Optical time-of-flight
Housing design (light emission)	Rectangular
Sensing range max.	50 mm ... 1,400 mm ¹⁾
Sensing range	100 mm ... 1,400 mm ²⁾ ³⁾
Distance value	
Measuring range	100 mm ... 1,400 mm ¹⁾
Resolution	1,000 µm
Repeatability	1,1 mm ... 1,5 mm ^{4) 5) 6)}
Accuracy	Typ. ± 20 mm, typ. ± 15 mm ^{7) 8)}
Type of light	Visible red light
Light source	Laser ⁹⁾
Light spot size (distance)	Ø 10 mm (1,400 mm)
Wave length	658 nm
Laser class	1 (IEC 60825-1 / CDRH 21 CFR 1040.10 & 1040.11)

¹⁾ Object with 6 ... 90% remission (based on standard white, DIN 5033).

²⁾ Adjustable.

³⁾ Object with 90% remission (based on standard white, DIN 5033).

⁴⁾ Equivalent to 1 σ .

⁵⁾ See characteristic curves repeatability.

⁶⁾ 6% ... 90% remission factor.

⁷⁾ 50 ... 1000 mm.

⁸⁾ 1000 ... 1400 mm.

⁹⁾ Average service life: 100,000 h at $T_J = +25 \text{ }^\circ\text{C}$.

Adjustment	Single teach-in button (2 x)
Safety-related parameters	
MTTF _D	124 years
DC _{avg}	0 %
T _M (mission time)	20 years

1) Object with 6 ... 90% remission (based on standard white, DIN 5033).

2) Adjustable.

3) Object with 90% remission (based on standard white, DIN 5033).

4) Equivalent to 1 σ .

5) See characteristic curves repeatability.

6) 6% ... 90% remission factor.

7) 50 ... 1000 mm.

8) 1000 ... 1400 mm.

9) Average service life: 100,000 h at T_U = +25 °C.

Electronics

Supply voltage U_B	12 V DC ... 30 V DC ^{1) 2)}
Ripple	< 5 V _{pp} ³⁾
Current consumption	70 mA ⁴⁾
Switching output	Push-pull: PNP/NPN ⁵⁾
Number of switching outputs	1 (Q ₁) ⁵⁾
Switching mode	Light switching ⁵⁾
Output current I_{max.}	≤ 50 mA
Response time	≤ 16.7 ms ⁶⁾
Switching frequency	30 Hz ⁷⁾
Analog output	4 mA ... 20 mA (≤ 450 Ω) / 0 V ... 10 V (≥ 50 kΩ) / switchable
Resolution of analog output	12 bit
Output time	≤ 16.7 ms
Input	Sender off
Circuit protection	A ⁸⁾ B ⁹⁾ C ¹⁰⁾
Protection class	III
Enclosure rating	IP67
Warm-up time	< 15 min ¹¹⁾

1) Limit values. Operated in short-circuit protected network: max. 8 A.

2) V_S min when using the voltage output = 13 V.

3) May not fall below or exceed U_V tolerances.

4) Without load. At V_S = 24 V.

5) Q₁ = 1 switching threshold, light switching.

6) Signal transit time with resistive load.

7) With light/dark ratio 1:1.

8) A = V_S connections reverse-polarity protected.

9) B = inputs and output reverse-polarity protected.

10) C = interference suppression.

11) Below T_U = -10 °C a warm-up time is necessary.

Initialization time	< 300 ms
----------------------------	----------

¹⁾ Limit values. Operated in short-circuit protected network: max. 8 A.

²⁾ V_S min when using the voltage output = 13 V.

³⁾ May not fall below or exceed U_V tolerances.

⁴⁾ Without load. At $V_S = 24$ V.

⁵⁾ $Q1 = 1$ switching threshold, light switching.

⁶⁾ Signal transit time with resistive load.

⁷⁾ With light/dark ratio 1:1.

⁸⁾ A = V_S connections reverse-polarity protected.

⁹⁾ B = inputs and output reverse-polarity protected.

¹⁰⁾ C = interference suppression.

¹¹⁾ Below $T_U = -10$ °C a warm-up time is necessary.

Mechanics

Dimensions (W x H x D)	20 mm x 49.6 mm x 44.2 mm
Housing material	Plastic, VISTAL®
Optics material	Plastic, PMMA
Weight	48 g
Connection type	Plug, M12, 5-pin

Ambient data

Ambient operating temperature	-35 °C ... +50 °C ¹⁾
Ambient temperature, storage	-40 °C ... +70 °C

¹⁾ For $V_S \leq 24$ V. When $T_U = 45$ °C or above, a maximum load resistance of 300 Ω ... 450 Ω is permitted on QA.

Classifications

ECLASS 5.0	27270904
ECLASS 5.1.4	27270904
ECLASS 6.0	27270904
ECLASS 6.2	27270904
ECLASS 7.0	27270904
ECLASS 8.0	27270904
ECLASS 8.1	27270904
ECLASS 9.0	27270904
ECLASS 10.0	27270904
ECLASS 11.0	27270904
ECLASS 12.0	27270903
ETIM 5.0	EC002719
ETIM 6.0	EC002719
ETIM 7.0	EC002719
ETIM 8.0	EC002719
UNSPSC 16.0901	39121528

Certificates

EU declaration of conformity	✓
UK declaration of conformity	✓

ACMA declaration of conformity	✓
Moroccan declaration of conformity	✓
China RoHS	✓
cULus certificate	✓
Laser safety (IEC 60825-1) certificate	✓

Dimensional drawing

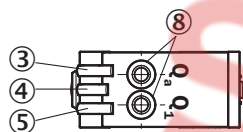
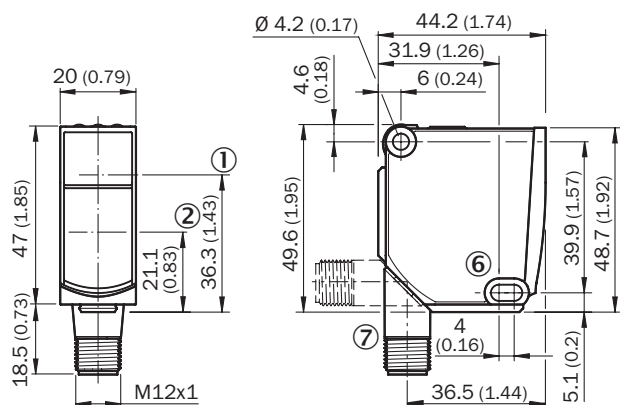

Dimensions in mm (inch)

- ① optical axis, sender
- ② optical axis, receiver
- ③ LED indicator yellow: Status of analog output
- ④ LED indicator green: power on
- ⑤ Status indicator LED, yellow: Status switching output
- ⑥ Mounting hole, Ø 4.2 mm
- ⑦ Connection
- ⑧ single teach-in button

Connection diagram Cd-375

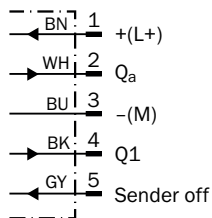

Characteristic curve

Min. distance from object to background in mm (inch)

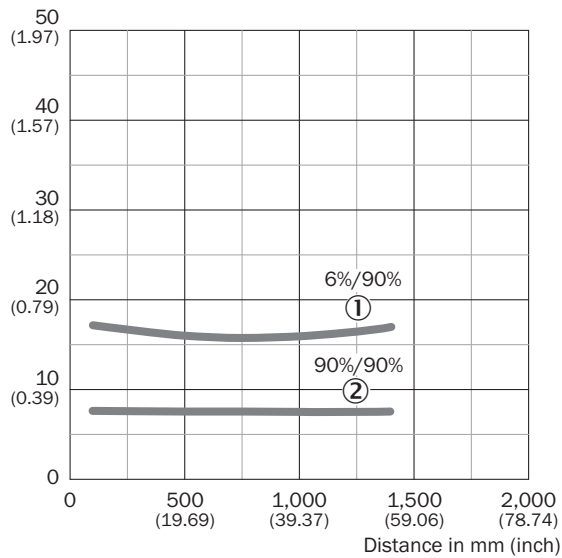

- ① Sensing range on black, 6% remission factor
- ② Sensing range on white, 90% remission factor

Light spot size

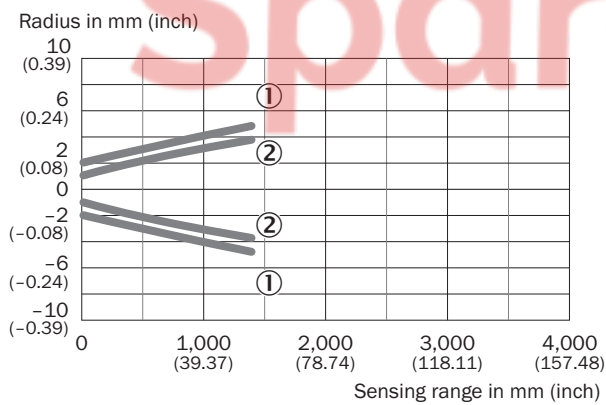

- ① Light spot horizontal
- ② Light spot vertical

Repeatability

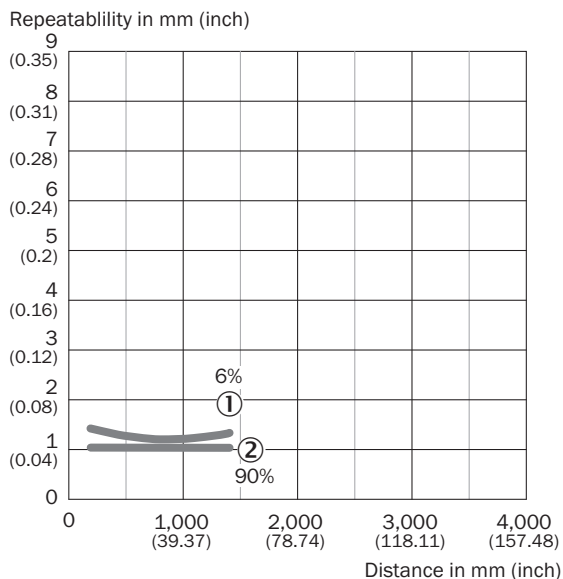



- ① 6 % remission, on black
- ② 90 % remission, on white



Recommended accessories

Other models and accessories → www.sick.com/WTT12_PowerProx

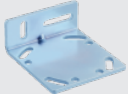
	Brief description	Type	part no.
connectors and cables			
	<ul style="list-style-type: none"> Connection type head A: Male connector, M12, 5-pin, straight, A-coded Description: Unshielded Connection systems: Screw-type terminals Permitted cross-section: ≤ 0.75 mm² Note: For field bus technology 	STE-1205-G	6022083
	<ul style="list-style-type: none"> Connection type head A: Female connector, M12, 5-pin, straight, A-coded Connection type head B: Flying leads Signal type: Sensor/actuator cable Cable: 5 m, 5-wire, PVC Description: Sensor/actuator cable, unshielded Application: Zones with chemicals, Uncontaminated zones 	YF2A15-050VB5XLEAX	2096240
Mounting systems			
	<ul style="list-style-type: none"> Description: Mounting brackets Suitable for: PowerProx 	BEF-WTT12L	2078538

SICK AT A GLANCE

SICK is one of the leading manufacturers of intelligent sensors and sensor solutions for industrial applications. A unique range of products and services creates the perfect basis for controlling processes securely and efficiently, protecting individuals from accidents and preventing damage to the environment.

We have extensive experience in a wide range of industries and understand their processes and requirements. With intelligent sensors, we can deliver exactly what our customers need. In application centers in Europe, Asia and North America, system solutions are tested and optimized in accordance with customer specifications. All this makes us a reliable supplier and development partner.

Comprehensive services complete our offering: SICK LifeTime Services provide support throughout the machine life cycle and ensure safety and productivity.

For us, that is “Sensor Intelligence.”

WORLDWIDE PRESENCE:

Contacts and other locations – www.sick.com

SpareCruX