

# MZT7-03VPS-KRD

MZT7

CYLINDER SENSORS

**SICK**  
Sensor Intelligence.

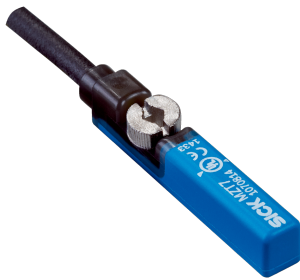

### Ordering information

Type	part no.
MZT7-03VPS-KRD	1082422

Other models and accessories → [www.sick.com/MZT7](http://www.sick.com/MZT7)



### Detailed technical data

#### Features

<b>Cylinder type</b>	T-slot
<b>Cylinder types with adapter</b>	Profile cylinder Tie rod cylinder Round body cylinder Dovetail groove cylinder SMC rail CDQ2 SMC rail ECDQ2
<b>Housing length</b>	29.5 mm
<b>Switching output</b>	PNP
<b>Switching frequency</b>	1,000 Hz
<b>Output function</b>	NO
<b>Electrical wiring</b>	DC 3-wire
<b>Enclosure rating</b>	IP65 <sup>1)</sup> IP67

<sup>1)</sup> According to EN 60529.

#### Mechanics/electronics

<b>Supply voltage</b>	10 V DC ... 30 V DC
<b>Power consumption</b>	8 mA, without load
<b>Voltage drop</b>	≤ 2 V
<b>Continuous current I<sub>a</sub></b>	≤ 100 mA
<b>Protection class</b>	III
<b>Response sensitivity, typ.</b>	3 mT
<b>Overrun distance, typ.</b>	10 mm <sup>1)</sup>
<b>Hysteresis, typ.</b>	< 0.8 mT
<b>Reproducibility</b>	≤ 0.1 mT <sup>2)</sup>
<b>Reverse polarity protection</b>	Yes

<sup>1)</sup> Distance covered by the encoder magnet while the sensor outputs a switching signal.

<sup>2)</sup> Supply voltage U<sub>B</sub> and constant ambient temperature T<sub>a</sub>.

<b>Short-circuit protection</b>	Yes
<b>Status indicator LED</b>	Yes
<b>Teach-in</b>	No
<b>Ambient operating temperature</b>	-30 °C ... +80 °C
<b>Shock and vibration resistance</b>	30 g, 11 ms / 10 ... 55 Hz, 1 mm
<b>EMC</b>	According to EN 60947-5-2
<b>Connection type</b>	Cable with plug M8, 3-pin, with knurled nut, drag chain use, 0.3 m
<b>Connection type Detail</b>	
Conductor cross section	0.14 mm <sup>2</sup>
Cable diameter	Ø 2.9 mm
Bending radius	With fixed installation > 8 x cable diameter For flexible use > 12 x cable diameter
Cable outlet	Axial
<b>Material</b>	
Housing	Plastic
Cable	PUR
<b>UL File No.</b>	NRKH.E181493 & NRKH7.E181493

<sup>1)</sup> Distance covered by the encoder magnet while the sensor outputs a switching signal.

<sup>2)</sup> Supply voltage  $U_B$  and constant ambient temperature  $T_a$ .

### Safety-related parameters

<b>MTTF<sub>D</sub></b>	1,300 years
<b>DC<sub>avg</sub></b>	0 %
<b>T<sub>M</sub> (mission time)</b>	20 years

### Classifications

<b>ECLASS 5.0</b>	27270104
<b>ECLASS 5.1.4</b>	27270104
<b>ECLASS 6.0</b>	27270104
<b>ECLASS 6.2</b>	27270104
<b>ECLASS 7.0</b>	27270104
<b>ECLASS 8.0</b>	27270104
<b>ECLASS 8.1</b>	27270104
<b>ECLASS 9.0</b>	27270104
<b>ECLASS 10.0</b>	27270104
<b>ECLASS 11.0</b>	27270104
<b>ECLASS 12.0</b>	27274301
<b>ETIM 5.0</b>	EC002544
<b>ETIM 6.0</b>	EC002544
<b>ETIM 7.0</b>	EC002544
<b>ETIM 8.0</b>	EC002544
<b>UNSPSC 16.0901</b>	39122230

### Certificates

<b>EU declaration of conformity</b>	✓
<b>UK declaration of conformity</b>	✓
<b>ACMA declaration of conformity</b>	✓
<b>Moroccan declaration of conformity</b>	✓
<b>China RoHS</b>	✓
<b>cULus certificate</b>	✓

### Installation note

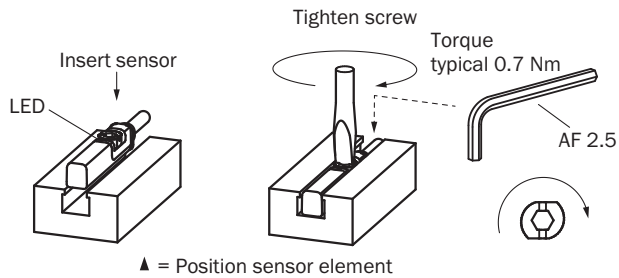

### Connection diagram Cd-002

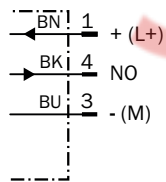

Functional principle Overrun distance



Note: Sensor housing may differ; representation corresponds to "NO contact" output function; overrun distance = switching point width + hysteresis

- ① Position sensor element
- ② Width of the switching point
- ③ Hysteresis
- ④ Direction of movement of the magnet

### Dimensional drawing Cable with plug M8, with knurled nut

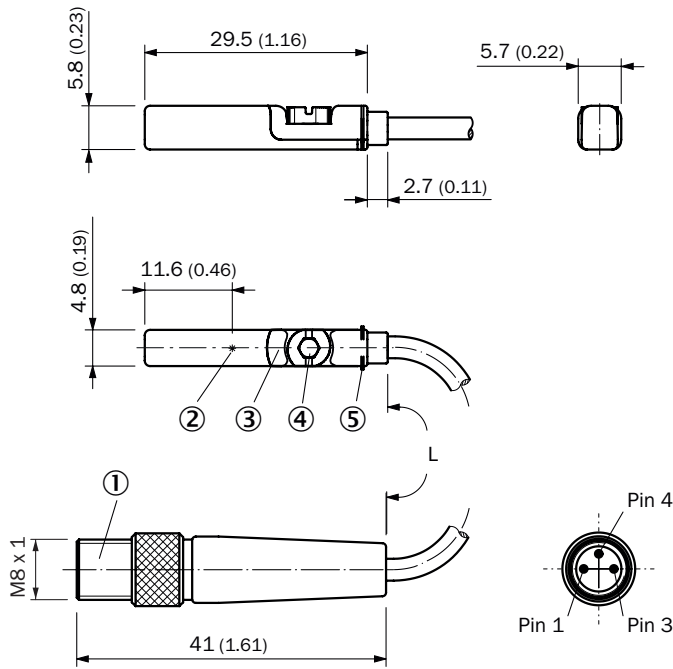

Dimensions in mm (inch)

- ① Connection
- ② Position sensor element
- ③ Display LED
- ④ Fixing screw SW 2.5
- ⑤ retaining ribs

Part no.	Type	L	Number of cores
1094040	MZT7-03VPS-KRDS10	150 mm	3
1082422	MZT7-03VPS-KRD	300 mm	3
1084695	MZT7-03VPS-KRDS04	300 mm	3
1089066	MZT7-03VNS-KRD	300 mm	3
1070821	MZT7-03VPS-KR0	500 mm	3
1070823	MZT7-03VPS-KR0	500 mm	3
1084694	MZT7-03VPS-KR0S03	500 mm	3
1088702	MZT7-03VPS-KRDS08	1000 mm	3



## Recommended accessories

Other models and accessories → [www.sick.com/MZT7](http://www.sick.com/MZT7)

	Brief description	Type	part no.
Mounting systems			
	<ul style="list-style-type: none"> <li><b>Description:</b> Mounting bracket on round body cylinder with piston diameter of 8 mm ... 130 mm, ambient temperature min -30 °C max 80 °C</li> <li><b>Material:</b> Stainless steel, Zinc cast</li> <li><b>Details:</b> Stainless steel, Zinc cast</li> <li><b>Packing unit:</b> 1 piece</li> <li><b>Suitable for:</b> T-slot</li> </ul>	BEF-KHZ-RT1-130	2077684
	<ul style="list-style-type: none"> <li><b>Description:</b> Mounting bracket on round body cylinder with piston diameter of 8 mm ... 25 mm, ambient temperature min -30 °C max 80 °C</li> <li><b>Material:</b> Stainless steel, Zinc cast</li> <li><b>Details:</b> Stainless steel, Zinc cast</li> <li><b>Packing unit:</b> 1 piece</li> <li><b>Suitable for:</b> T-slot</li> </ul>	BEF-KHZ-RT1-25	2077682
	<ul style="list-style-type: none"> <li><b>Description:</b> Mounting bracket on round body cylinder with piston diameter of 8 mm ... 63 mm, ambient temperature min -30 °C max 80 °C</li> <li><b>Material:</b> Stainless steel, Zinc cast</li> <li><b>Details:</b> Stainless steel, Zinc cast</li> <li><b>Packing unit:</b> 1 piece</li> <li><b>Suitable for:</b> T-slot</li> </ul>	BEF-KHZ-RT1-63	2077683
	<ul style="list-style-type: none"> <li><b>Description:</b> Mounting bracket on round body cylinder with piston diameter of 12 mm, ambient temperature min 0 °C max 50 °C</li> <li><b>Dimensions (W x H x L):</b> 22.4 m</li> <li><b>Material:</b> Plastic, Aluminum</li> <li><b>Details:</b> Plastic, Aluminum</li> <li><b>Packing unit:</b> 1 piece</li> <li><b>Suitable for:</b> T-slot</li> </ul>	BEF-KHZ-RT-12	2077681
	<ul style="list-style-type: none"> <li><b>Description:</b> Mounting bracket on round body cylinder with piston diameter of 16 mm, ambient temperature min 0 °C max 50 °C</li> <li><b>Dimensions (W x H x L):</b> 26.6 m</li> <li><b>Material:</b> Plastic, Aluminum</li> <li><b>Details:</b> Plastic, Aluminum</li> <li><b>Packing unit:</b> 1 piece</li> <li><b>Suitable for:</b> T-slot</li> </ul>	BEF-KHZ-RT-16	2077680
	<ul style="list-style-type: none"> <li><b>Description:</b> Mounting bracket on round body cylinder with piston diameter of 20 mm, ambient temperature min 0 °C max 50 °C</li> <li><b>Dimensions (W x H x L):</b> 30.6 m</li> <li><b>Material:</b> Plastic, Aluminum</li> <li><b>Details:</b> Plastic, Aluminum</li> <li><b>Packing unit:</b> 1 piece</li> <li><b>Suitable for:</b> T-slot</li> </ul>	BEF-KHZ-RT-20	2077679
	<ul style="list-style-type: none"> <li><b>Description:</b> Mounting bracket on round body cylinder with piston diameter of 25 mm, ambient temperature min 0 °C max 50 °C</li> <li><b>Dimensions (W x H x L):</b> 35.7 m</li> <li><b>Material:</b> Plastic, Aluminum</li> <li><b>Details:</b> Plastic, Aluminum</li> <li><b>Packing unit:</b> 1 piece</li> <li><b>Suitable for:</b> T-slot</li> </ul>	BEF-KHZ-RT-25	2077678
	<ul style="list-style-type: none"> <li><b>Description:</b> Mounting bracket on round body cylinder with piston diameter of 32 mm, ambient temperature min 0 °C max 50 °C</li> <li><b>Dimensions (W x H x L):</b> 42.9 m</li> <li><b>Material:</b> Plastic, Aluminum</li> <li><b>Details:</b> Plastic, Aluminum</li> <li><b>Packing unit:</b> 1 piece</li> <li><b>Suitable for:</b> T-slot</li> </ul>	BEF-KHZ-RT-32	2077677
	<ul style="list-style-type: none"> <li><b>Description:</b> Mounting bracket on round body cylinder with piston diameter of 40 mm, ambient temperature min 0 °C max 50 °C</li> <li><b>Dimensions (W x H x L):</b> 50.9 m</li> <li><b>Material:</b> Plastic, Aluminum</li> <li><b>Details:</b> Plastic, Aluminum</li> <li><b>Packing unit:</b> 1 piece</li> </ul>	BEF-KHZ-RT-40	2077676

	Brief description	Type	part no.
	<ul style="list-style-type: none"> <li>• <b>Suitable for:</b> T-slot</li> <li>• <b>Description:</b> Mounting bracket on round body cylinder with piston diameter of 50 mm, ambient temperature min 0 °C max 50 °C</li> <li>• <b>Dimensions (W x H x L):</b> 61.8 mm</li> <li>• <b>Material:</b> Plastic, Aluminum</li> <li>• <b>Details:</b> Plastic, Aluminum</li> <li>• <b>Packing unit:</b> 1 piece</li> <li>• <b>Suitable for:</b> T-slot</li> </ul>	BEF-KHZ-RT-50	2077675
	<ul style="list-style-type: none"> <li>• <b>Description:</b> Mounting bracket on round body cylinder with piston diameter of 63 mm, ambient temperature min 0 °C max 50 °C</li> <li>• <b>Dimensions (W x H x L):</b> 73.9 mm</li> <li>• <b>Material:</b> Plastic, Aluminum</li> <li>• <b>Details:</b> Plastic, Aluminum</li> <li>• <b>Packing unit:</b> 1 piece</li> <li>• <b>Suitable for:</b> T-slot</li> </ul>	BEF-KHZ-RT-63	2077674
	<ul style="list-style-type: none"> <li>• <b>Description:</b> Mounting bracket for integrated profile cylinder/tie-rod cylinder</li> <li>• <b>Material:</b> Zinc diecast</li> <li>• <b>Details:</b> Zinc diecast</li> <li>• <b>Items supplied:</b> Mounting hardware included</li> </ul>	BEF-KHZ-PT1	2022702
	<ul style="list-style-type: none"> <li>• <b>Description:</b> Mounting bracket for mounting on SMC rails ECDQ2 (T-slot)</li> <li>• <b>Material:</b> Aluminum</li> <li>• <b>Details:</b> Aluminum</li> <li>• <b>Items supplied:</b> Without mounting hardware</li> </ul>	BEF-KHZ-TT1	2046439
	<ul style="list-style-type: none"> <li>• <b>Description:</b> Mounting bracket for mounting on SMC rails CDQ2 (T-slot)</li> <li>• <b>Material:</b> Aluminum</li> <li>• <b>Details:</b> Aluminum</li> <li>• <b>Items supplied:</b> Without mounting hardware</li> </ul>	BEF-KHZ-TT2	2046440
	<ul style="list-style-type: none"> <li>• <b>Description:</b> Mounting bracket for cylinder with dovetail slot</li> <li>• <b>Material:</b> Aluminum</li> <li>• <b>Details:</b> Aluminum</li> <li>• <b>Items supplied:</b> Without mounting hardware</li> </ul>	BEF-KHZ-ST1	2022703
	<p>device protection and care</p> <ul style="list-style-type: none"> <li>• <b>Description:</b> Protective adapter</li> <li>• <b>Material:</b> Zinc diecast</li> <li>• <b>Items supplied:</b> Mounting hardware included</li> <li>• <b>Suitable for:</b> MZT7, RZT7, MZT8</li> </ul>	BEF-SG-MRZT	2077201

	Brief description	Type	part no.
connectors and cables			
	<ul style="list-style-type: none"> <li>• <b>Connection type head A:</b> Male connector, M8, 3-pin, straight, A-coded</li> <li>• <b>Description:</b> Unshielded</li> <li>• <b>Connection systems:</b> Screw-type terminals</li> <li>• <b>Permitted cross-section:</b> 0.14 mm<sup>2</sup> ... 0.5 mm<sup>2</sup></li> </ul>	STE-0803-G	6037322
	<ul style="list-style-type: none"> <li>• <b>Connection type head A:</b> Female connector, M8, 3-pin, straight, A-coded</li> <li>• <b>Description:</b> Unshielded</li> <li>• <b>Connection systems:</b> Screw-type terminals</li> <li>• <b>Permitted cross-section:</b> 0.14 mm<sup>2</sup> ... 0.5 mm<sup>2</sup></li> </ul>	DOS-0803-G	7902077
	<ul style="list-style-type: none"> <li>• <b>Connection type head A:</b> Female connector, M8, 3-pin, angled, A-coded</li> <li>• <b>Description:</b> Unshielded</li> <li>• <b>Connection systems:</b> Solder connection</li> <li>• <b>Permitted cross-section:</b> ≤ 0.25 mm<sup>2</sup></li> </ul>	DOS-0803-W	7902078
	<ul style="list-style-type: none"> <li>• <b>Connection type head A:</b> Female connector, M8, 3-pin, straight, A-coded</li> <li>• <b>Connection type head B:</b> Flying leads</li> <li>• <b>Signal type:</b> Sensor/actuator cable</li> <li>• <b>Cable:</b> 2 m, 3-wire, PVC</li> <li>• <b>Description:</b> Sensor/actuator cable, unshielded</li> <li>• <b>Application:</b> Zones with chemicals, Uncontaminated zones</li> </ul>	YF8U13-020VA1XLEAX	2095860
	<ul style="list-style-type: none"> <li>• <b>Connection type head A:</b> Female connector, M8, 3-pin, straight, A-coded</li> <li>• <b>Connection type head B:</b> Flying leads</li> <li>• <b>Signal type:</b> Sensor/actuator cable</li> <li>• <b>Cable:</b> 5 m, 3-wire, PVC</li> <li>• <b>Description:</b> Sensor/actuator cable, unshielded</li> <li>• <b>Application:</b> Zones with chemicals, Uncontaminated zones</li> </ul>	YF8U13-050VA1XLEAX	2095884
	<ul style="list-style-type: none"> <li>• <b>Connection type head A:</b> Female connector, M8, 3-pin, angled, A-coded</li> <li>• <b>Connection type head B:</b> Flying leads</li> <li>• <b>Signal type:</b> Sensor/actuator cable</li> <li>• <b>Cable:</b> 2 m, 3-wire, PVC</li> <li>• <b>Description:</b> Sensor/actuator cable, unshielded</li> <li>• <b>Application:</b> Zones with chemicals, Uncontaminated zones</li> </ul>	YG8U13-020VA1XLEAX	2096165
	<ul style="list-style-type: none"> <li>• <b>Connection type head A:</b> Female connector, M8, 3-pin, angled, A-coded</li> <li>• <b>Connection type head B:</b> Flying leads</li> <li>• <b>Signal type:</b> Sensor/actuator cable</li> <li>• <b>Cable:</b> 5 m, 3-wire, PVC</li> <li>• <b>Description:</b> Sensor/actuator cable, unshielded</li> <li>• <b>Application:</b> Zones with chemicals, Uncontaminated zones</li> </ul>	YG8U13-050VA1XLEAX	2096166
	<ul style="list-style-type: none"> <li>• <b>Connection type head A:</b> Female connector, M8, 3-pin, straight, A-coded</li> <li>• <b>Connection type head B:</b> Flying leads</li> <li>• <b>Signal type:</b> Sensor/actuator cable</li> <li>• <b>Cable:</b> 2 m, 3-wire, PUR, halogen-free</li> <li>• <b>Description:</b> Sensor/actuator cable, unshielded</li> <li>• <b>Application:</b> Uncontaminated zones, Zones with oils and lubricants, Robot, Drag chain operation</li> </ul>	YF8U13-020UA1XLEAX	2094782
	<ul style="list-style-type: none"> <li>• <b>Connection type head A:</b> Female connector, M8, 3-pin, straight, A-coded</li> <li>• <b>Connection type head B:</b> Flying leads</li> <li>• <b>Signal type:</b> Sensor/actuator cable</li> <li>• <b>Cable:</b> 5 m, 3-wire, PUR, halogen-free</li> <li>• <b>Description:</b> Sensor/actuator cable, unshielded</li> <li>• <b>Application:</b> Uncontaminated zones, Zones with oils and lubricants, Robot, Drag chain operation</li> </ul>	YF8U13-050UA1XLEAX	2094788
	<ul style="list-style-type: none"> <li>• <b>Connection type head A:</b> Female connector, M8, 3-pin, angled, A-coded</li> <li>• <b>Connection type head B:</b> Flying leads</li> <li>• <b>Signal type:</b> Sensor/actuator cable</li> <li>• <b>Cable:</b> 2 m, 3-wire, PUR, halogen-free</li> <li>• <b>Description:</b> Sensor/actuator cable, unshielded</li> <li>• <b>Application:</b> Uncontaminated zones, Zones with oils and lubricants, Robot, Drag chain operation</li> </ul>	YG8U13-020UA1XLEAX	2094794
	<ul style="list-style-type: none"> <li>• <b>Connection type head A:</b> Female connector, M8, 3-pin, angled, A-coded</li> <li>• <b>Connection type head B:</b> Flying leads</li> <li>• <b>Signal type:</b> Sensor/actuator cable</li> <li>• <b>Cable:</b> 5 m, 3-wire, PUR, halogen-free</li> <li>• <b>Description:</b> Sensor/actuator cable, unshielded</li> </ul>	YG8U13-050UA1XLEAX	2095586

	Brief description	Type	part no.
	<ul style="list-style-type: none"> <li>• <b>Application:</b> Uncontaminated zones, Zones with oils and lubricants, Robot, Drag chain operation</li> <li>• <b>Connection type head A:</b> Female connector, M8, 3-pin, angled, A-coded</li> <li>• <b>Connection type head B:</b> Flying leads</li> <li>• <b>Signal type:</b> Sensor/actuator cable</li> <li>• <b>Cable:</b> 0.6 m, 3-wire, PUR, halogen-free</li> <li>• <b>Description:</b> Sensor/actuator cable, unshielded</li> <li>• <b>Application:</b> Uncontaminated zones, Zones with oils and lubricants, Robot, Drag chain operation</li> </ul>	YG8U13-C60UA1XLEAX	2145889
	<ul style="list-style-type: none"> <li>• <b>Connection type head A:</b> Female connector, M8, 3-pin, angled, A-coded</li> <li>• <b>Connection type head B:</b> Flying leads</li> <li>• <b>Signal type:</b> Sensor/actuator cable</li> <li>• <b>Cable:</b> 3 m, 3-wire, PUR, halogen-free</li> <li>• <b>Description:</b> Sensor/actuator cable, unshielded</li> <li>• <b>Application:</b> Uncontaminated zones, Zones with oils and lubricants, Robot, Drag chain operation</li> </ul>	YG8U13-030UA1XLEAX	2145891
	<ul style="list-style-type: none"> <li>• <b>Connection type head A:</b> Female connector, M8, 3-pin, straight, A-coded</li> <li>• <b>Connection type head B:</b> Flying leads</li> <li>• <b>Signal type:</b> Sensor/actuator cable</li> <li>• <b>Cable:</b> 0.6 m, 3-wire, PVC</li> <li>• <b>Description:</b> Sensor/actuator cable, unshielded</li> <li>• <b>Application:</b> Zones with chemicals, Uncontaminated zones</li> </ul>	YF8U13-C60VA1XLEAX	2146368



## SICK AT A GLANCE

SICK is one of the leading manufacturers of intelligent sensors and sensor solutions for industrial applications. A unique range of products and services creates the perfect basis for controlling processes securely and efficiently, protecting individuals from accidents and preventing damage to the environment.

We have extensive experience in a wide range of industries and understand their processes and requirements. With intelligent sensors, we can deliver exactly what our customers need. In application centers in Europe, Asia and North America, system solutions are tested and optimized in accordance with customer specifications. All this makes us a reliable supplier and development partner.

Comprehensive services complete our offering: SICK LifeTime Services provide support throughout the machine life cycle and ensure safety and productivity.

For us, that is “Sensor Intelligence.”

### WORLDWIDE PRESENCE:

Contacts and other locations – [www.sick.com](http://www.sick.com)

SpareCruX