

SpareCruX



## LFP2000-N6NMC

LFP Inox

LEVEL SENSORS

**SICK**  
Sensor Intelligence.



Illustration may differ



### Ordering information

| Type          | part no. |
|---------------|----------|
| LFP2000-N6NMC | 1080634  |

Other models and accessories → [www.sick.com/LFP\\_Inox](http://www.sick.com/LFP_Inox)

### Detailed technical data

#### Features

|                            |                              |
|----------------------------|------------------------------|
| <b>Medium</b>              | Fluids                       |
| <b>Measurement</b>         | Switch, Continuous           |
| <b>Design</b>              | Standard amplifier           |
| <b>Probe type</b>          | Rod probe in hygienic design |
| <b>Probe length</b>        | 2,000 mm                     |
| <b>Process pressure</b>    | -1 bar ... 16 bar            |
| <b>Process temperature</b> | -20 °C ... +150 °C           |

#### Performance

|   |  |
|---|--|
| <b>Accuracy of sensor element</b>             | ± 5 mm                                       |
| <b>Reproducibility</b>                        | ≤ 2 mm                                       |
| <b>Resolution</b>                             | 1 mm   |
| <b>Response time</b>                          | 400 ms <sup>1)</sup>                         |
| <b>Dielectricity constant</b>                 | ≥ 5 for rod probe<br>≥ 1.8 with coaxial tube |
| <b>Conductivity</b>                           | No limitation                                |
| <b>Deactivated area at process connection</b> | 25 mm <sup>2)</sup>                          |
| <b>Deactivated area at end of probe</b>       | ≥ 10 mm <sup>3)</sup>                        |
| <b>MTTF</b>                                   | 194.3 years (EN ISO 13849-1)                 |
| <b>Display</b>                                | ✓  |

<sup>1)</sup> Dependent on measuring mode (high speed < 400 ms, high accuracy < 2,800 ms).

<sup>2)</sup> With parameterized container with water under reference conditions, otherwise 40 mm.

<sup>3)</sup> With water under reference conditions.

## Electronics

|                                |   |
|--------------------------------|---|
| <b>Communication interface</b> | IO-Link   |
| <b>Supply voltage</b>          | 12 V DC ... 30 V DC <sup>1)</sup>   |
| <b>Power consumption</b>       | ≤ 75 mA at 24 V DC without output load  |
| <b>Initialization time</b>     | ≤ 2 s   |
| <b>Protection class</b>        | III   |
| <b>Connection type</b>         | M12 round connector x 1, 8-pin  |
| <b>Output signal</b>           | 1 x PNP + 3 x PNP/NPN + 4 mA ... 20 mA / 0 V ... 10 V   |
| <b>Output load</b>             | 4 mA ... 20 mA < 500 Ohm at U <sub>v</sub> > 13,5 V, 4 mA ... 20 mA < 400 Ohm at U <sub>v</sub> > 12 V, 0 V ... 10 V > 750 Ohm at U <sub>v</sub> 14 ≥ V |
| <b>Hysteresis</b>              | ≥ 2 mm <sup>2)</sup>  |
| <b>Output current</b>          | < 100 mA  |
| <b>Inductive load</b>          | < 1 H   |
| <b>Capacitive load</b>         | < 100 nF  |
| <b>Enclosure rating</b>        | IP67 (EN 60529)<br>IP69 (EN 60529)  |
| <b>Temperature drift</b>       | < 0.1 mm/K  |
| <b>Lower signal level</b>      | 3.8 mA ... 4 mA, 0 V  |
| <b>Upper signal level</b>      | 20 mA ... 20.5 mA, 10.5 V   |

<sup>1)</sup> All connections are polarity protected. All outputs are overload and short-circuit protected.

<sup>2)</sup> Freely adjustable.

## Mechanics

|                           |  |
|---------------------------|--|
| <b>Wetted parts</b>       | Stainless steel 1.4404 / 316L<br>PEEK              |
| <b>Surface roughness</b>  | Ra ≤ 0,8 μm  |
| <b>Process connection</b> | ¾" NPT   |
| <b>Housing material</b>   | Stainless steel 1,4305                             |
| <b>Housing design</b>     | With viewing window made from PMMA (acrylic glass) |
| <b>Max. probe load</b>    | ≤ 6 Nm   |

## Ambient data

|                                      |                        |
|--------------------------------------|------------------------|
| <b>Ambient operating temperature</b> | -20 °C ... +60 °C      |
| <b>Ambient temperature, storage</b>  | -40 °C ... +80 °C      |
| <b>Outdoor use</b>                   | Only with weather hood |

## Certificates

|   |   |
|---|---|
| <b>EU declaration of conformity</b>       | ✓ |
| <b>UK declaration of conformity</b>       | ✓ |
| <b>ACMA declaration of conformity</b>     | ✓ |
| <b>Moroccan declaration of conformity</b> | ✓ |
| <b>China RoHS</b>                         | ✓ |
| <b>FDA certificate</b>                    | ✓ |
| <b>cULus certificate</b>                  | ✓ |
| <b>IO-Link certificate</b>                | ✓ |

|  |   |
|--|---|
| <b>Food contact material manufacturer declaration</b>                        | ✓ |
| <b>Information according to Art. 3 of Data Act (Regulation EU 2023/2854)</b> | ✓ |

Classifications

|                       |          |
|-----------------------|----------|
| <b>ECLASS 5.0</b>     | 27200513 |
| <b>ECLASS 5.1.4</b>   | 27200513 |
| <b>ECLASS 6.0</b>     | 27200513 |
| <b>ECLASS 6.2</b>     | 27200513 |
| <b>ECLASS 7.0</b>     | 27200513 |
| <b>ECLASS 8.0</b>     | 27200513 |
| <b>ECLASS 8.1</b>     | 27200513 |
| <b>ECLASS 9.0</b>     | 27200513 |
| <b>ECLASS 10.0</b>    | 27200513 |
| <b>ECLASS 11.0</b>    | 27200513 |
| <b>ECLASS 12.0</b>    | 27200513 |
| <b>ETIM 5.0</b>       | EC001447 |
| <b>ETIM 6.0</b>       | EC001447 |
| <b>ETIM 7.0</b>       | EC001447 |
| <b>ETIM 8.0</b>       | EC001447 |
| <b>UNSPSC 16.0901</b> | 41113710 |

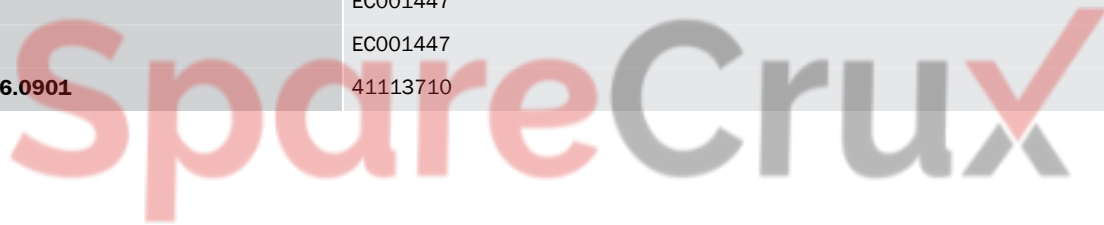

Dimensional drawing

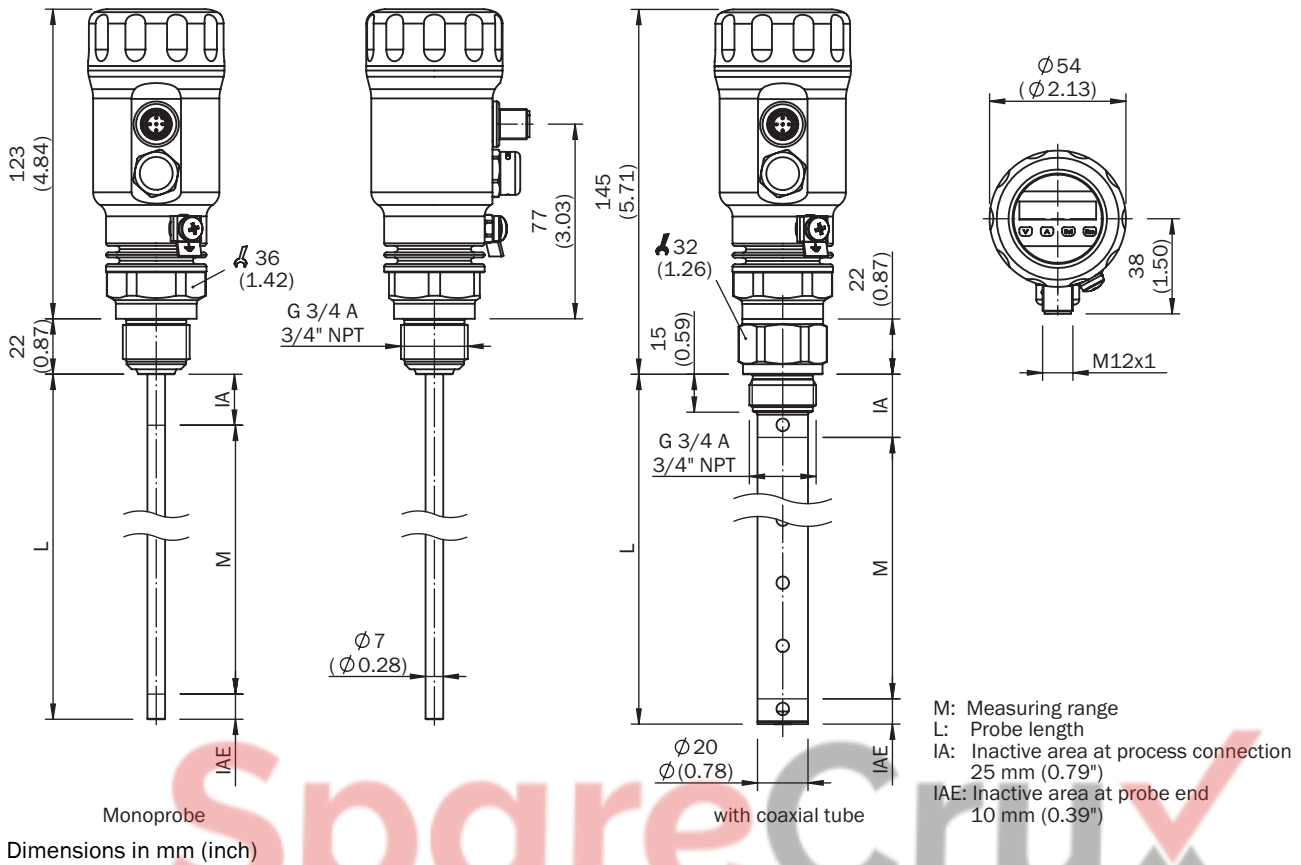

Connection type M12 round connector, 8-pin

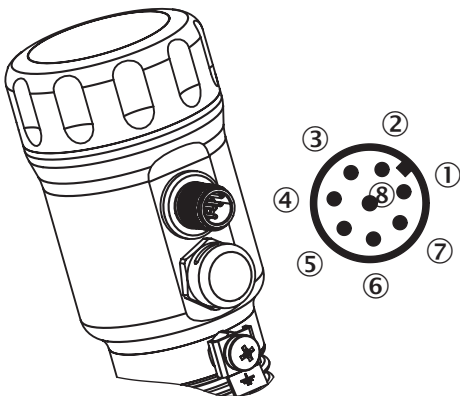







The wire colors for 8-pin cables are not uniform. Always note the pin assignment of the sensor.



- ① L<sup>+</sup>: Supply voltage
- ② Q<sub>2</sub>: Switching output 2, PNP/NPN
- ③ M: Ground, reference ground for current-/voltage output
- ④ C/Q<sub>1</sub>: Switching output 1, PNP/IO-Link-communication
- ⑤ Q<sub>3</sub>: Switching output 3, PNP/NPN
- ⑥ Q<sub>4</sub>: Switching output 4, PNP/NPN
- ⑦ Q<sub>A</sub>: Analog current-/voltage output
- ⑧ No function

### Recommended accessories

Other models and accessories → [www.sick.com/LFP\\_Inox](http://www.sick.com/LFP_Inox)

|   | Brief description   | Type                    | part no. |
|---|---|-------------------------|----------|
| device protection and care  |   |                         |          |
|    | <ul style="list-style-type: none"> <li><b>Description:</b> Weather protection cover for LFP Inox, material: 304</li> </ul>  | APR-WP-LFP001-0001      | 2069530  |
|    | <ul style="list-style-type: none"> <li><b>Description:</b> Cover for LFP Inox with inspection window, material 1.4305 and PMMA</li> </ul>   | Cover with front screen | 2067267  |
|    | <ul style="list-style-type: none"> <li><b>Description:</b> Cover closed, material 1.4305</li> </ul>   | Cover closed            | 2067269  |
| Mounting systems  |   |                         |          |
|    | <ul style="list-style-type: none"> <li><b>Description:</b> Centering for bypass- and immersion tube installation with diameter 40 mm ... 100 mm</li> <li><b>Dimensions (W x H x L):</b> 100 mm x 5 mm x 100 mm</li> <li><b>Material:</b> PTFE</li> <li><b>Details:</b> PTFE</li> <li><b>Packing unit:</b> 1 piece</li> <li><b>Usable for:</b> LFP Inox</li> </ul> | BEF-FL-BYRD40-LFP1      | 2059612  |
|  | <ul style="list-style-type: none"> <li><b>Description:</b> Hygienic process connection adapter, Tri-Clamp 1" and 1 1/2", including acceptance test certificate 3.1; Ra ≤ 0.4 µm, hygienic in accordance with EHEDG in combination with T-seals or Tri-Clamp seals from Combifit International B.V.</li> </ul>   | BEF-HA-TCLI10-LFP2      | 2126242  |
|  | <ul style="list-style-type: none"> <li><b>Description:</b> Hygienic process connection adapter, Tri-Clamp 2"; including acceptance test certificate 3.1; Ra ≤ 0.4 µm, hygienic in accordance with EHEDG in combination with T-seals or Tri-Clamp seals from Combifit International B.V.</li> </ul>  | BEF-HA-TCLI20-LFP2      | 2126243  |
|  | <ul style="list-style-type: none"> <li><b>Description:</b> Weld-in flange, hygienic, G 3/4" including acceptance test certificate 3.1, Ra ≤ 0.4 µm</li> <li><b>Material:</b> Stainless steel</li> <li><b>Details:</b> Stainless steel 1.4404</li> </ul>   | BEF-HA-SWFL54-LFP2      | 2122489  |

|   | Brief description  | Type            | part no. |
|---|--|-----------------|----------|
| connectors and cables   |  |                 |          |
|    | <ul style="list-style-type: none"> <li>• <b>Connection type head A:</b> Female connector, M12, 5-pin, straight</li> <li>• <b>Connection type head B:</b> Flying leads</li> <li>• <b>Signal type:</b> Sensor/actuator cable</li> <li>• <b>Cable:</b> 2 m, 5-wire, PP</li> <li>• <b>Description:</b> Sensor/actuator cable, unshielded</li> <li>• <b>Connection systems:</b> Flying leads</li> <li>• <b>Note:</b> This product is generally resistant to chemical cleaning agents (see ECOLAB) and other chemical compounds such as H2O2 and CH2O2. Before permanent installation is carried out, the material's resistance to the cleaning agent being used must be checked., Resistant against lactic acid &amp; hydrogen peroxide (H2O2)</li> <li>• <b>Application:</b> Hygienic and washdown zones, Drag chain operation</li> </ul>  | DOL-1205-G02MRN | 6058494  |
|    | <ul style="list-style-type: none"> <li>• <b>Connection type head A:</b> Female connector, M12, 5-pin, straight</li> <li>• <b>Connection type head B:</b> Flying leads</li> <li>• <b>Signal type:</b> Sensor/actuator cable</li> <li>• <b>Cable:</b> 5 m, 5-wire, PP</li> <li>• <b>Description:</b> Sensor/actuator cable, unshielded</li> <li>• <b>Connection systems:</b> Flying leads</li> <li>• <b>Note:</b> This product is generally resistant to chemical cleaning agents (see ECOLAB) and other chemical compounds such as H2O2 and CH2O2. Before permanent installation is carried out, the material's resistance to the cleaning agent being used must be checked., Resistant against lactic acid &amp; hydrogen peroxide (H2O2)</li> <li>• <b>Application:</b> Hygienic and washdown zones, Drag chain operation</li> </ul>  | DOL-1205-G05MRN | 6058495  |
|    | <ul style="list-style-type: none"> <li>• <b>Connection type head A:</b> Female connector, M12, 5-pin, straight</li> <li>• <b>Connection type head B:</b> Flying leads</li> <li>• <b>Signal type:</b> Sensor/actuator cable</li> <li>• <b>Cable:</b> 10 m, 5-wire, PP</li> <li>• <b>Description:</b> Sensor/actuator cable, unshielded</li> <li>• <b>Connection systems:</b> Flying leads</li> <li>• <b>Note:</b> This product is generally resistant to chemical cleaning agents (see ECOLAB) and other chemical compounds such as H2O2 and CH2O2. Before permanent installation is carried out, the material's resistance to the cleaning agent being used must be checked., Resistant against lactic acid &amp; hydrogen peroxide (H2O2)</li> <li>• <b>Application:</b> Hygienic and washdown zones, Drag chain operation</li> </ul> | DOL-1205-G10MRN | 6058496  |
|  | <ul style="list-style-type: none"> <li>• <b>Connection type head A:</b> Female connector, M12, 5-pin, straight</li> <li>• <b>Connection type head B:</b> Flying leads</li> <li>• <b>Signal type:</b> Sensor/actuator cable</li> <li>• <b>Cable:</b> 25 m, 5-wire, PVC</li> <li>• <b>Description:</b> Sensor/actuator cable, unshielded</li> <li>• <b>Connection systems:</b> Flying leads</li> <li>• <b>Note:</b> This product is generally resistant to chemical cleaning agents (see ECOLAB). Please do not use cleaning agents of any other Kind., Not resistant against lactic acid &amp; hydrogen peroxide (H2O2)</li> <li>• <b>Application:</b> Hygienic and washdown zones</li> </ul>   | DOL-1205-G25MNI | 6052628  |
|  | <ul style="list-style-type: none"> <li>• <b>Connection type head A:</b> Female connector, M12, 5-pin, straight</li> <li>• <b>Connection type head B:</b> Flying leads</li> <li>• <b>Signal type:</b> Sensor/actuator cable</li> <li>• <b>Cable:</b> 25 m, 5-wire, PP</li> <li>• <b>Description:</b> Sensor/actuator cable, unshielded</li> <li>• <b>Connection systems:</b> Flying leads</li> <li>• <b>Note:</b> This product is generally resistant to chemical cleaning agents (see ECOLAB) and other chemical compounds such as H2O2 and CH2O2. Before permanent installation is carried out, the material's resistance to the cleaning agent being used must be checked., Resistant against lactic acid &amp; hydrogen peroxide (H2O2)</li> <li>• <b>Application:</b> Hygienic and washdown zones, Drag chain operation</li> </ul> | DOL-1205-G25MRN | 6058497  |
|  | <ul style="list-style-type: none"> <li>• <b>Connection type head A:</b> Female connector, M12, 5-pin, straight</li> <li>• <b>Connection type head B:</b> Flying leads</li> <li>• <b>Signal type:</b> Sensor/actuator cable</li> <li>• <b>Cable:</b> 2 m, 5-wire, PVC</li> <li>• <b>Description:</b> Sensor/actuator cable, unshielded</li> <li>• <b>Connection systems:</b> Flying leads</li> <li>• <b>Note:</b> This product is generally resistant to chemical cleaning agents (see ECOLAB). Please do not use cleaning agents of any other Kind., Not resistant against lactic acid &amp; hydrogen peroxide (H2O2)</li> <li>• <b>Application:</b> Hygienic and washdown zones</li> </ul>  | DOL-1205-G02MNI | 6052625  |
|  | <ul style="list-style-type: none"> <li>• <b>Connection type head A:</b> Female connector, M12, 5-pin, straight</li> <li>• <b>Connection type head B:</b> Flying leads</li> <li>• <b>Signal type:</b> Sensor/actuator cable</li> <li>• <b>Cable:</b> 5 m, 5-wire, PVC</li> <li>• <b>Description:</b> Sensor/actuator cable, unshielded</li> <li>• <b>Connection systems:</b> Flying leads</li> </ul>  | DOL-1205-G05MNI | 6052626  |

|   | Brief description  | Type               | part no. |
|---|--|--------------------|----------|
|  | <ul style="list-style-type: none"> <li><b>Note:</b> This product is generally resistant to chemical cleaning agents (see ECOLAB). Please do not use cleaning agents of any other Kind., Not resistant against lactic acid &amp; hydrogen peroxide (H2O2)</li> <li><b>Application:</b> Hygienic and washdown zones</li> <li><b>Connection type head A:</b> Female connector, M12, 5-pin, straight</li> <li><b>Connection type head B:</b> Flying leads</li> <li><b>Signal type:</b> Sensor/actuator cable</li> <li><b>Cable:</b> 10 m, 5-wire, PVC</li> <li><b>Description:</b> Sensor/actuator cable, unshielded</li> <li><b>Connection systems:</b> Flying leads</li> <li><b>Note:</b> This product is generally resistant to chemical cleaning agents (see ECOLAB). Please do not use cleaning agents of any other Kind., Not resistant against lactic acid &amp; hydrogen peroxide (H2O2)</li> <li><b>Application:</b> Hygienic and washdown zones</li> </ul> | DOL-1205-G10MNI    | 6052627  |
|  | <ul style="list-style-type: none"> <li><b>Connection type head A:</b> Female connector, M12, 5-pin, straight</li> <li><b>Connection type head B:</b> Flying leads</li> <li><b>Signal type:</b> Sensor/actuator cable</li> <li><b>Cable:</b> 20 m, 5-wire, PP</li> <li><b>Description:</b> Sensor/actuator cable, unshielded</li> <li><b>Connection systems:</b> Flying leads</li> <li><b>Note:</b> This product is generally resistant to chemical cleaning agents (see ECOLAB) and other chemical compounds such as H2O2 and CH2O2. Before permanent installation is carried out, the material's resistance to the cleaning agent being used must be checked., Resistant against lactic acid &amp; hydrogen peroxide (H2O2)</li> <li><b>Application:</b> Hygienic and washdown zones, Drag chain operation</li> </ul>   | YF2AP5-200PA3XLEAX | 2146868  |
|  | <ul style="list-style-type: none"> <li><b>Connection type head A:</b> Female connector, M12, 5-pin, straight</li> <li><b>Connection type head B:</b> Flying leads</li> <li><b>Signal type:</b> Sensor/actuator cable</li> <li><b>Cable:</b> 40 m, 5-wire, PP</li> <li><b>Description:</b> Sensor/actuator cable, unshielded</li> <li><b>Connection systems:</b> Flying leads</li> <li><b>Note:</b> This product is generally resistant to chemical cleaning agents (see ECOLAB) and other chemical compounds such as H2O2 and CH2O2. Before permanent installation is carried out, the material's resistance to the cleaning agent being used must be checked., Resistant against lactic acid &amp; hydrogen peroxide (H2O2)</li> <li><b>Application:</b> Hygienic and washdown zones, Drag chain operation</li> </ul>   | YF2AP5-400PA3XLEAX | 2146869  |

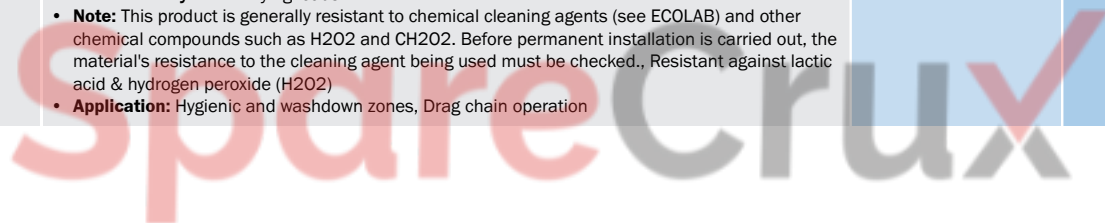

## SICK AT A GLANCE

SICK is one of the leading manufacturers of intelligent sensors and sensor solutions for industrial applications. A unique range of products and services creates the perfect basis for controlling processes securely and efficiently, protecting individuals from accidents and preventing damage to the environment.

We have extensive experience in a wide range of industries and understand their processes and requirements. With intelligent sensors, we can deliver exactly what our customers need. In application centers in Europe, Asia and North America, system solutions are tested and optimized in accordance with customer specifications. All this makes us a reliable supplier and development partner.

Comprehensive services complete our offering: SICK LifeTime Services provide support throughout the machine life cycle and ensure safety and productivity.

For us, that is “Sensor Intelligence.”

### WORLDWIDE PRESENCE:

Contacts and other locations – [www.sick.com](http://www.sick.com)

SpareCruX