



GTB10-N1211  
G10

SpareCruz

PHOTOELECTRIC SENSORS

**SICK**  
Sensor Intelligence.



Illustration may differ

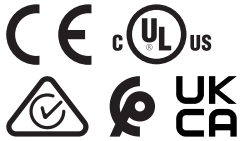

### Ordering information

Type	part no.
GTB10-N1211	1065858

Other models and accessories → [www.sick.com/G10](http://www.sick.com/G10)

### Detailed technical data

#### Features

<b>Functional principle</b>	Photoelectric proximity sensor
<b>Functional principle detail</b>	Background suppression
<b>Dimensions (W x H x D)</b>	20 mm x 50 mm x 39 mm
<b>Housing design (light emission)</b>	Rectangular
<b>Sensing range max.</b>	20 mm ... 950 mm <sup>1)</sup>
<b>Type of light</b>	Visible red light
<b>Light source</b>	PinPoint LED <sup>2)</sup>
<b>Light spot size (distance)</b>	Ø 8 mm (700 mm)
<b>Wave length</b>	625 nm
<b>Adjustment</b>	Potentiometer, 5 turns

<sup>1)</sup> Object with 90% remission (based on standard white, DIN 5033).

<sup>2)</sup> Average service life: 100,000 h at T<sub>J</sub> = +25 °C.

#### Mechanics/electronics

<b>Supply voltage U<sub>B</sub></b>	10 V DC ... 30 V DC <sup>1)</sup>
<b>Ripple</b>	< 5 V <sub>pp</sub> <sup>2)</sup>

<sup>1)</sup> Limit values when operated in short-circuit protected network: max. 8 A.

<sup>2)</sup> May not fall below or exceed U<sub>V</sub> tolerances.

<sup>3)</sup> Signal transit time with resistive load.

<sup>4)</sup> With light/dark ratio 1:1.

<sup>5)</sup> Do not bend below 0 °C.

<sup>6)</sup> A = V<sub>S</sub> connections reverse-polarity protected.

<sup>7)</sup> B = inputs and output reverse-polarity protected.

<sup>8)</sup> C = interference suppression.

<sup>9)</sup> D = outputs overcurrent and short-circuit protected.

<sup>10)</sup> Complies with the UL325 standard when used with sturdy protection hood (e.g. BEF-G10WSG, 2071960).

<b>Current consumption</b>	20 mA
<b>Switching output</b>	NPN
<b>Switching mode</b>	Light/dark switching
<b>Switching mode selector</b>	Selectable via light/dark selector
<b>Output current I<sub>max.</sub></b>	≤ 100 mA
<b>Response time</b>	≤ 500 μs <sup>3)</sup>
<b>Switching frequency</b>	1,000 Hz <sup>4)</sup>
<b>Connection type</b>	Cable, 3-wire, 2 m <sup>5)</sup>
<b>Cable material</b>	Plastic, PVC
<b>Conductor cross section</b>	0.14 mm <sup>2</sup>
<b>Circuit protection</b>	A <sup>6)</sup> B <sup>7)</sup> C <sup>8)</sup> D <sup>9)</sup>
<b>Protection class</b>	III
<b>Weight</b>	90 g
<b>Housing material</b>	Plastic, ABS/PMMA
<b>Enclosure rating</b>	IP67
<b>Electromagnetic compatibility (EMC)</b>	EN 60947-5-2
<b>Ambient operating temperature</b>	-30 °C ... +60 °C
<b>Ambient temperature, storage</b>	-40 °C ... +70 °C
<b>UL File No.</b>	NRKH.E348498 & NRKH7.E348498
<b>More standards</b>	UL325 <sup>10)</sup>

1) Limit values when operated in short-circuit protected network: max. 8 A.

2) May not fall below or exceed U<sub>y</sub> tolerances.

3) Signal transit time with resistive load.

4) With light/dark ratio 1:1.

5) Do not bend below 0 °C.

6) A = V<sub>S</sub> connections reverse-polarity protected.

7) B = inputs and output reverse-polarity protected.

8) C = interference suppression.

9) D = outputs overcurrent and short-circuit protected.

10) Complies with the UL325 standard when used with sturdy protection hood (e.g. BEF-G10WSG, 2071960).

SpareCruz

## Certificates

<b>EU declaration of conformity</b>	✓
<b>UK declaration of conformity</b>	✓
<b>ACMA declaration of conformity</b>	✓
<b>Moroccan declaration of conformity</b>	✓
<b>China RoHS</b>	✓
<b>cULus certificate</b>	✓
<b>Photobiological safety (DIN EN 62471) certificate</b>	✓

## Classifications

<b>ECLASS 5.0</b>	27270904
-------------------	----------

<b>ECLASS 5.1.4</b>	27270904
<b>ECLASS 6.0</b>	27270904
<b>ECLASS 6.2</b>	27270904
<b>ECLASS 7.0</b>	27270904
<b>ECLASS 8.0</b>	27270904
<b>ECLASS 8.1</b>	27270904
<b>ECLASS 9.0</b>	27270904
<b>ECLASS 10.0</b>	27270904
<b>ECLASS 11.0</b>	27270904
<b>ECLASS 12.0</b>	27270903
<b>ETIM 5.0</b>	EC002719
<b>ETIM 6.0</b>	EC002719
<b>ETIM 7.0</b>	EC002719
<b>ETIM 8.0</b>	EC002719
<b>UNSPSC 16.0901</b>	39121528

Adjustments GTB10, GTE10, GL10G, DC

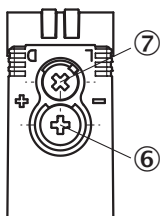

- ⑥ Adjustment of sensing range
- ⑦ Light/dark selector

Connection diagram Cd-044

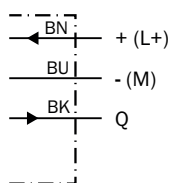

SpareCruz

**Characteristic curve GTB10, redlight**

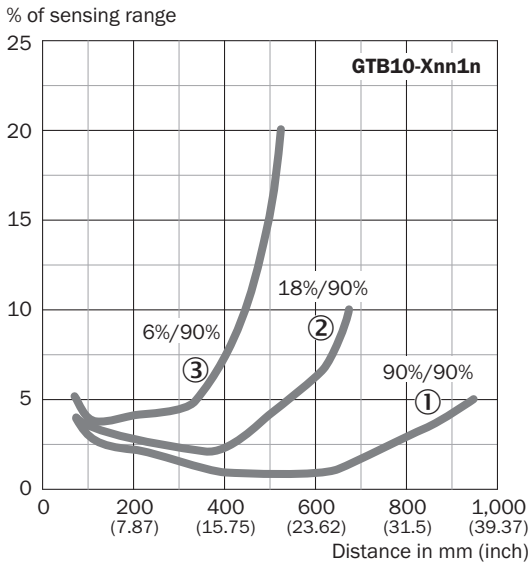

- ① Sensing range on white, 90% remission factor
- ② Sensing range on gray, 18% remission factor
- ③ Sensing range on black, 6% remission factor

**Light spot size**

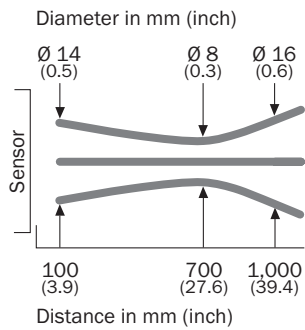

**Sensing range diagram GTB10, redlight**

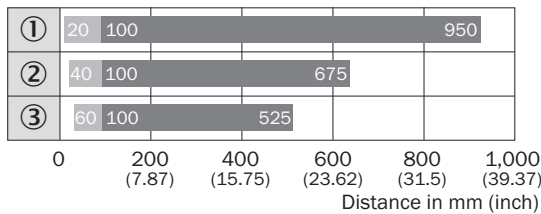

- Sensing range
- Sensing range max.
- ① Sensing range on white, 90% remission factor
- ② Sensing range on gray, 18% remission factor
- ③ Sensing range on black, 6% remission factor

Dimensional drawing GTB10, DC, cable

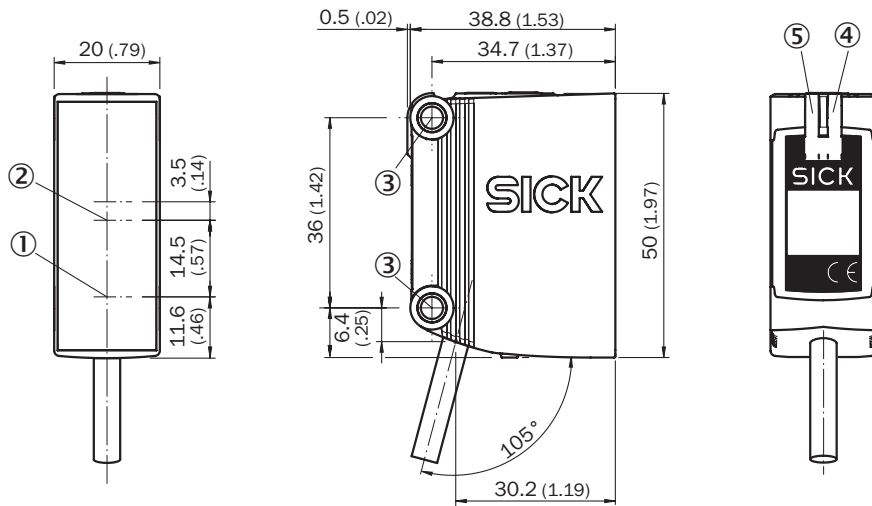



Dimensions in mm (inch)

- ① Center of optical axis, sender
- ② Center of optical axis, receiver
- ③ Mounting hole, Ø 4.2 mm
- ④ LED indicator yellow: Status of received light beam
- ⑤ LED indicator green: power on

Recommended accessories

Other models and accessories → [www.sick.com/G10](http://www.sick.com/G10)

	Brief description	Type	part no.
connectors and cables			
	<ul style="list-style-type: none"> <li>• <b>Connection type head A:</b> Male connector, M8, 3-pin, straight, A-coded</li> <li>• <b>Description:</b> Unshielded</li> <li>• <b>Connection systems:</b> Screw-type terminals</li> <li>• <b>Permitted cross-section:</b> 0.14 mm<sup>2</sup> ... 0.5 mm<sup>2</sup></li> </ul>	STE-0803-G	6037322
Mounting systems			
	<ul style="list-style-type: none"> <li>• <b>Description:</b> Q-Lock, bar clamp system for G10 and reflector P250</li> <li>• <b>Material:</b> Zinc diecast, steel</li> <li>• <b>Details:</b> Die-cast zinc, steel, zinc coated</li> <li>• <b>Suitable for:</b> G10 and reflector P250</li> </ul>	BEF-KHSQ12R01	2071260
	<ul style="list-style-type: none"> <li>• <b>Description:</b> Mounting bracket with articulated arm</li> <li>• <b>Material:</b> Steel</li> <li>• <b>Details:</b> Steel, zinc coated</li> <li>• <b>Items supplied:</b> Mounting hardware included</li> <li>• <b>Suitable for:</b> W16, W26, W11, W12, W23, W27, Dx50, W280, G10</li> </ul>	BEF-WN-MULTI2	2093945

## SICK AT A GLANCE

SICK is one of the leading manufacturers of intelligent sensors and sensor solutions for industrial applications. A unique range of products and services creates the perfect basis for controlling processes securely and efficiently, protecting individuals from accidents and preventing damage to the environment.

We have extensive experience in a wide range of industries and understand their processes and requirements. With intelligent sensors, we can deliver exactly what our customers need. In application centers in Europe, Asia and North America, system solutions are tested and optimized in accordance with customer specifications. All this makes us a reliable supplier and development partner.

Comprehensive services complete our offering: SICK LifeTime Services provide support throughout the machine life cycle and ensure safety and productivity.

For us, that is “Sensor Intelligence.”

## WORLDWIDE PRESENCE:

Contacts and other locations –[www.sick.com](http://www.sick.com)

SpareCruz