



GSE10-P4211
G10

SpareCruz

PHOTOELECTRIC SENSORS

SICK
Sensor Intelligence.



Illustration may differ

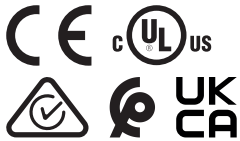

Ordering information

| Type | part no. |
|-------------|----------|
| GSE10-P4211 | 1064706 |

Other models and accessories → www.sick.com/G10

Detailed technical data

Features

| | |
|--|-----------------------------------|
| Functional principle | Through-beam photoelectric sensor |
| Dimensions (W x H x D) | 20 mm x 50 mm x 39 mm |
| Housing design (light emission) | Rectangular |
| Sensing range max. | 0 m ... 40 m |
| Sensing range | 0 m ... 35 m |
| Type of light | Visible red light |
| Light source | PinPoint LED ¹⁾ |
| Light spot size (distance) | Ø 180 mm (15 m) |
| Wave length | 625 nm |
| Adjustment | Potentiometer, 270 ° |

¹⁾ Average service life: 100,000 h at T_U = +25 °C.

Mechanics/electronics

| | |
|-------------------------------------|-----------------------------------|
| Supply voltage U_B | 10 V DC ... 30 V DC ¹⁾ |
| Ripple | < 5 V _{pp} ²⁾ |
| Power consumption, sender | ≤ 15 mA |
| Power consumption, receiver | ≤ 20 mA |
| Switching output | PNP |
| Switching mode | Light/dark switching |

¹⁾ Limit values when operated in short-circuit protected network: max. 8 A.

²⁾ May not fall below or exceed U_V tolerances.

³⁾ Signal transit time with resistive load.

⁴⁾ With light/dark ratio 1:1.

⁵⁾ A = V_S connections reverse-polarity protected.

⁶⁾ B = inputs and output reverse-polarity protected.

⁷⁾ C = interference suppression.

⁸⁾ D = outputs overcurrent and short-circuit protected.

⁹⁾ Complies with the UL325 standard when used with sturdy protection hood (e.g. BEF-G10WSG, 2071960).

| | |
|--|--|
| Switching mode selector | Selectable via light/dark selector |
| Output current I_{max} | ≤ 100 mA |
| Response time | ≤ 500 μ s ³⁾ |
| Switching frequency | 1,000 Hz ⁴⁾ |
| Connection type | Male connector M12, 4-pin |
| Circuit protection | A ⁵⁾ B ⁶⁾ C ⁷⁾ D ⁸⁾ |
| Protection class | III |
| Weight | 70 g |
| Housing material | Plastic, ABS/PMMA |
| Enclosure rating | IP67 |
| Electromagnetic compatibility (EMC) | EN 60947-5-2 |
| Test input | Sender OFF at "Test" 0 V |
| Ambient operating temperature | -30 °C ... +60 °C |
| Ambient temperature, storage | -40 °C ... +70 °C |
| UL File No. | NRKH.E348498 & NRKH7.E348498 |
| More standards | UL325 ⁹⁾ |

1) Limit values when operated in short-circuit protected network: max. 8 A.

2) May not fall below or exceed U_V tolerances.

3) Signal transit time with resistive load.

4) With light/dark ratio 1:1.

5) A = V_S connections reverse-polarity protected.

6) B = inputs and output reverse-polarity protected.

7) C = interference suppression.

8) D = outputs overcurrent and short-circuit protected.

9) Complies with the UL325 standard when used with sturdy protection hood (e.g. BEF-G10WSG, 2071960).

Safety-related parameters

| | |
|-------------------------|-----------|
| MTTF_D | 864 years |
| DC_{avg} | 0 % |

Certificates

| | |
|--|---|
| EU declaration of conformity | ✓ |
| UK declaration of conformity | ✓ |
| ACMA declaration of conformity | ✓ |
| Moroccan declaration of conformity | ✓ |
| China RoHS | ✓ |
| cULus certificate | ✓ |
| Photobiological safety (DIN EN 62471) certificate | ✓ |

Classifications

| | |
|---------------------|----------|
| ECLASS 5.0 | 27270901 |
| ECLASS 5.1.4 | 27270901 |

| | |
|-----------------------|----------|
| ECLASS 6.0 | 27270901 |
| ECLASS 6.2 | 27270901 |
| ECLASS 7.0 | 27270901 |
| ECLASS 8.0 | 27270901 |
| ECLASS 8.1 | 27270901 |
| ECLASS 9.0 | 27270901 |
| ECLASS 10.0 | 27270901 |
| ECLASS 11.0 | 27270901 |
| ECLASS 12.0 | 27270901 |
| ETIM 5.0 | EC002716 |
| ETIM 6.0 | EC002716 |
| ETIM 7.0 | EC002716 |
| ETIM 8.0 | EC002716 |
| UNSPSC 16.0901 | 39121528 |

Adjustments

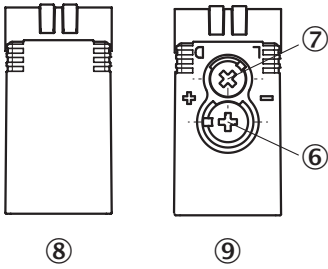

- ⑥ Adjustment of sensing range
- ⑦ Light/dark selector
- ⑧ sender
- ⑨ receiver

SpareCruz

Connection diagram Cd-073

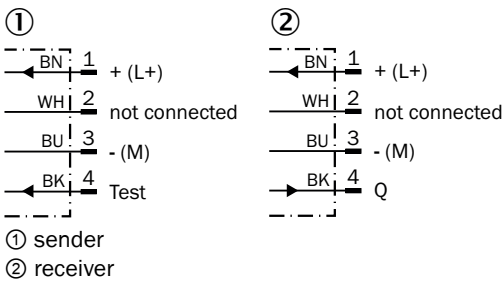

Characteristic curve GSE10, red light

Operating reserve

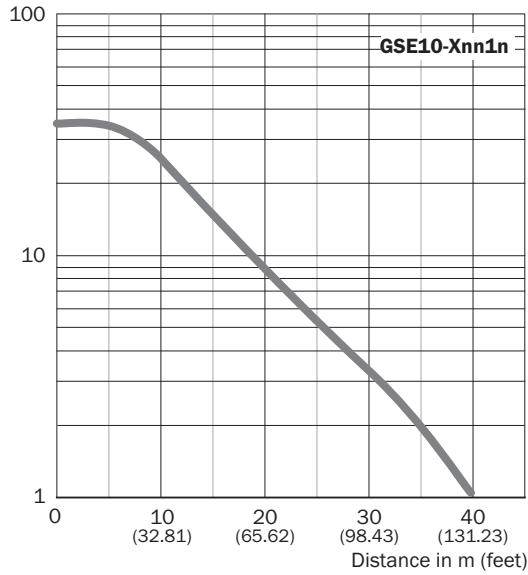

Light spot size GSE10, red light



Sensing range diagram GSE10, red light



Dimensional drawing GSE10, DC, connector

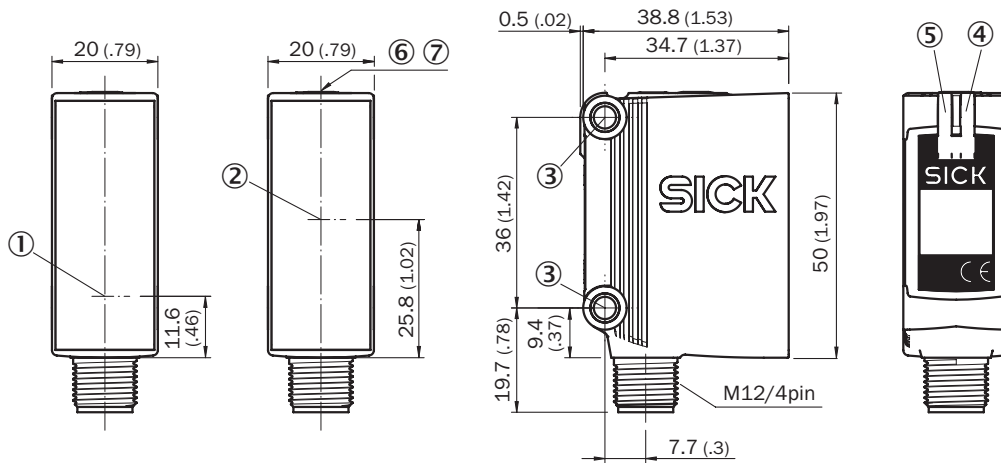



Dimensions in mm (inch)

- ① Center of optical axis, sender
- ② Center of optical axis, receiver
- ③ Mounting hole, Ø 4.2 mm
- ④ LED indicator yellow: Status of received light beam
- ⑤ LED indicator green: power on

Recommended accessories

Other models and accessories → www.sick.com/G10

| | Brief description | Type | part no. |
|---|--|---------------|----------|
| Mounting systems | | | |
|  | <ul style="list-style-type: none"> • Description: Q-Lock, bar clamp system for G10 and reflector P250 • Material: Zinc diecast, steel • Details: Die-cast zinc, steel, zinc coated • Suitable for: G10 and reflector P250 | BEF-KHSQ12R01 | 2071260 |
|  | <ul style="list-style-type: none"> • Description: Mounting bracket with articulated arm • Material: Steel • Details: Steel, zinc coated • Items supplied: Mounting hardware included • Suitable for: W16, W26, W11, W12, W23, W27, Dx50, W280, G10 | BEF-WN-MULTI2 | 2093945 |

| | Brief description | Type | part no. |
|---|--|--------------------|----------|
| connectors and cables | | | |
|  | <ul style="list-style-type: none"> • Connection type head A: Female connector, M12, 4-pin, straight, A-coded • Connection type head B: Flying leads • Signal type: Sensor/actuator cable • Cable: 5 m, 4-wire, PVC • Description: Sensor/actuator cable, unshielded • Application: Zones with chemicals, Uncontaminated zones | YF2A14-050VB3XLEAX | 2096235 |
|  | <ul style="list-style-type: none"> • Connection type head A: Male connector, M12, 4-pin, straight, A-coded • Description: Unshielded • Connection systems: Screw-type terminals • Permitted cross-section: ≤ 0.75 mm² | STE-1204-G | 6009932 |
|  | <ul style="list-style-type: none"> • Connection type head A: Female connector, M12, 4-pin, straight, A-coded • Connection type head B: Flying leads • Signal type: Sensor/actuator cable • Cable: 5 m, 4-wire, PUR, halogen-free • Description: Sensor/actuator cable, unshielded • Application: Uncontaminated zones, Zones with oils and lubricants, Robot, Drag chain operation | YF2A14-050UB3XLEAX | 2095608 |

SpareCruz

SICK AT A GLANCE

SICK is one of the leading manufacturers of intelligent sensors and sensor solutions for industrial applications. A unique range of products and services creates the perfect basis for controlling processes securely and efficiently, protecting individuals from accidents and preventing damage to the environment.

We have extensive experience in a wide range of industries and understand their processes and requirements. With intelligent sensors, we can deliver exactly what our customers need. In application centers in Europe, Asia and North America, system solutions are tested and optimized in accordance with customer specifications. All this makes us a reliable supplier and development partner.

Comprehensive services complete our offering: SICK LifeTime Services provide support throughout the machine life cycle and ensure safety and productivity.

For us, that is “Sensor Intelligence.”

WORLDWIDE PRESENCE:

Contacts and other locations –www.sick.com

SpareCruz