

SpareCruX



# LFP1700-N1NMB

LFP Inox

LEVEL SENSORS

**SICK**  
Sensor Intelligence.



Illustration may differ



### Ordering information

Type	part no.
LFP1700-N1NMB	1059422

Other models and accessories → [www.sick.com/LFP\\_Inox](http://www.sick.com/LFP_Inox)

### Detailed technical data

#### Features

<b>Medium</b>	Fluids
<b>Measurement</b>	Switch, Continuous
<b>Design</b>	Standard amplifier
<b>Probe type</b>	Rod probe in hygienic design
<b>Probe length</b>	1,700 mm
<b>Process pressure</b>	-1 bar ... 16 bar
<b>Process temperature</b>	-20 °C ... +150 °C

#### Performance

<b>Accuracy of sensor element</b>	± 5 mm
<b>Reproducibility</b>	≤ 2 mm
<b>Resolution</b>	1 mm
<b>Response time</b>	400 ms <sup>1)</sup>
<b>Dielectricity constant</b>	≥ 5 for rod probe ≥ 1.8 with coaxial tube
<b>Conductivity</b>	No limitation
<b>Deactivated area at process connection</b>	25 mm <sup>2)</sup>
<b>Deactivated area at end of probe</b>	≥ 10 mm <sup>3)</sup>
<b>MTTF</b>	194.3 years (EN ISO 13849-1)
<b>Display</b>	✓

<sup>1)</sup> Dependent on measuring mode (high speed < 400 ms, high accuracy < 2,800 ms).

<sup>2)</sup> With parameterized container with water under reference conditions, otherwise 40 mm.

<sup>3)</sup> With water under reference conditions.

## Electronics

<b>Communication interface</b>	IO-Link
<b>Supply voltage</b>	12 V DC ... 30 V DC <sup>1)</sup>
<b>Power consumption</b>	≤ 75 mA at 24 V DC without output load
<b>Initialization time</b>	≤ 2 s
<b>Protection class</b>	III
<b>Connection type</b>	Round connector M12 x 1, 5-pin
<b>Output signal</b>	1 x PNP + 1 x PNP/NPN + 4 mA ... 20 mA / 0 V ... 10 V
<b>Output load</b>	4 mA ... 20 mA < 500 Ohm at U <sub>v</sub> > 13,5 V, 4 mA ... 20 mA < 400 Ohm at U <sub>v</sub> > 12 V, 0 V ... 10 V > 750 Ohm at U <sub>v</sub> 14 ≥ V
<b>Hysteresis</b>	≥ 2 mm <sup>2)</sup>
<b>Output current</b>	< 100 mA
<b>Inductive load</b>	< 1 H
<b>Capacitive load</b>	< 100 nF
<b>Enclosure rating</b>	IP67 (EN 60529) IP69 (EN 60529)
<b>Temperature drift</b>	< 0.1 mm/K
<b>Lower signal level</b>	3.8 mA ... 4 mA, 0 V
<b>Upper signal level</b>	20 mA ... 20.5 mA, 10.5 V

<sup>1)</sup> All connections are polarity protected. All outputs are overload and short-circuit protected.

<sup>2)</sup> Freely adjustable.

## Mechanics

<b>Wetted parts</b>	Stainless steel 1.4404 / 316L PEEK
<b>Surface roughness</b>	Ra ≤ 0,8 μm
<b>Process connection</b>	¾" NPT
<b>Housing material</b>	Stainless steel 1,4305
<b>Housing design</b>	With viewing window made from PMMA (acrylic glass)
<b>Max. probe load</b>	≤ 6 Nm

## Ambient data

<b>Ambient operating temperature</b>	-20 °C ... +60 °C
<b>Ambient temperature, storage</b>	-40 °C ... +80 °C
<b>Outdoor use</b>	Only with weather hood

## Certificates

<b>EU declaration of conformity</b>	✓
<b>UK declaration of conformity</b>	✓
<b>ACMA declaration of conformity</b>	✓
<b>Moroccan declaration of conformity</b>	✓
<b>China RoHS</b>	✓
<b>FDA certificate</b>	✓
<b>cULus certificate</b>	✓
<b>IO-Link certificate</b>	✓

<b>Food contact material manufacturer declaration</b>	✓
<b>Information according to Art. 3 of Data Act (Regulation EU 2023/2854)</b>	✓

Classifications

<b>ECLASS 5.0</b>	27200513
<b>ECLASS 5.1.4</b>	27200513
<b>ECLASS 6.0</b>	27200513
<b>ECLASS 6.2</b>	27200513
<b>ECLASS 7.0</b>	27200513
<b>ECLASS 8.0</b>	27200513
<b>ECLASS 8.1</b>	27200513
<b>ECLASS 9.0</b>	27200513
<b>ECLASS 10.0</b>	27200513
<b>ECLASS 11.0</b>	27200513
<b>ECLASS 12.0</b>	27200513
<b>ETIM 5.0</b>	EC001447
<b>ETIM 6.0</b>	EC001447
<b>ETIM 7.0</b>	EC001447
<b>ETIM 8.0</b>	EC001447
<b>UNSPSC 16.0901</b>	41113710

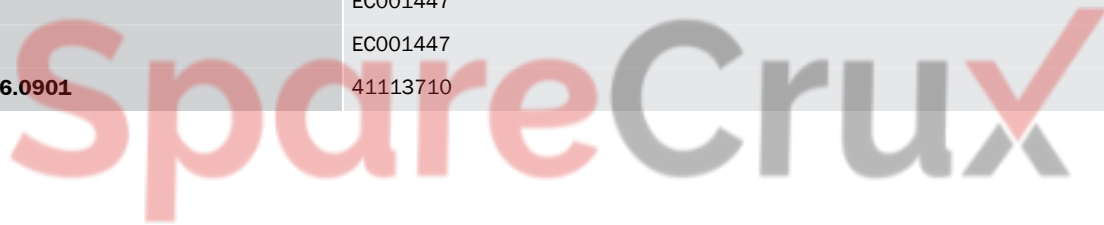

Dimensional drawing

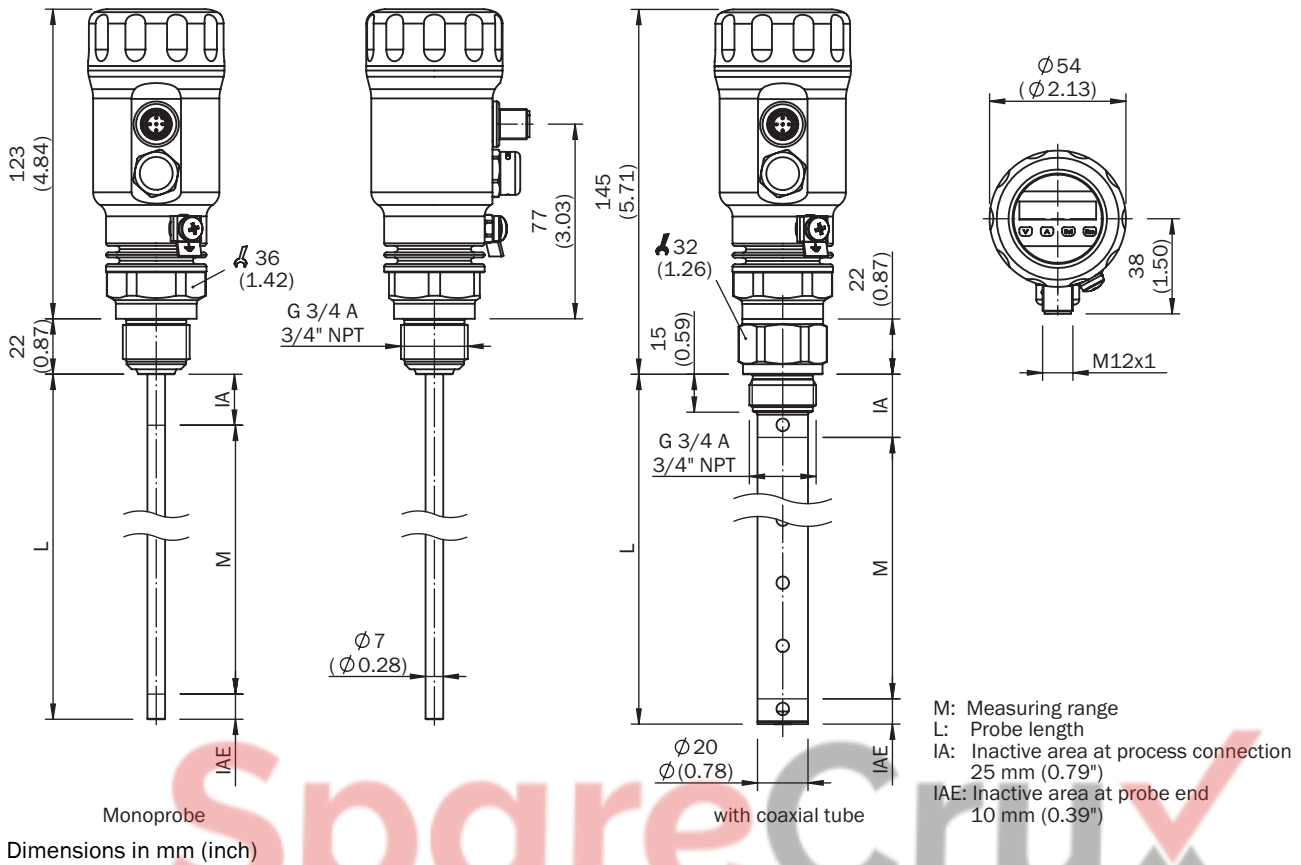







Connection type 5-pole M12 Connector





- ① L<sup>+</sup>: Supply voltage, brown
- ② Q<sub>A</sub>: Analog current-/voltage output, white
- ③ M: Ground, reference ground for current-/voltage output, blue
- ④ C/Q<sub>1</sub>: Switching output 1, PNP/IO-Link-communication, black
- ⑤ Q<sub>2</sub>: Switching output 2, PNP/NPN, grey

### Recommended accessories

Other models and accessories → [www.sick.com/LFP\\_Inox](http://www.sick.com/LFP_Inox)

	Brief description	Type	part no.
device protection and care			
	<ul style="list-style-type: none"> <li><b>Description:</b> Weather protection cover for LFP Inox, material: 304</li> </ul>	APR-WP-LFP001-0001	2069530
	<ul style="list-style-type: none"> <li><b>Description:</b> Cover for LFP Inox with inspection window, material 1.4305 and PMMA</li> </ul>	Cover with front screen	2067267
	<ul style="list-style-type: none"> <li><b>Description:</b> Cover closed, material 1.4305</li> </ul>	Cover closed	2067269
Mounting systems			
	<ul style="list-style-type: none"> <li><b>Description:</b> Centering for bypass- and immersion tube installation with diameter 40 mm ... 100 mm</li> <li><b>Dimensions (W x H x L):</b> 100 mm x 5 mm x 100 mm</li> <li><b>Material:</b> PTFE</li> <li><b>Details:</b> PTFE</li> <li><b>Packing unit:</b> 1 piece</li> <li><b>Usable for:</b> LFP Inox</li> </ul>	BEF-FL-BYRD40-LFP1	2059612
	<ul style="list-style-type: none"> <li><b>Description:</b> Hygienic process connection adapter, Tri-Clamp 1" and 1 1/2", including acceptance test certificate 3.1; Ra ≤ 0.4 µm, hygienic in accordance with EHEDG in combination with T-seals or Tri-Clamp seals from Combifit International B.V.</li> </ul>	BEF-HA-TCLI10-LFP2	2126242
	<ul style="list-style-type: none"> <li><b>Description:</b> Hygienic process connection adapter, Tri-Clamp 2"; including acceptance test certificate 3.1; Ra ≤ 0.4 µm, hygienic in accordance with EHEDG in combination with T-seals or Tri-Clamp seals from Combifit International B.V.</li> </ul>	BEF-HA-TCLI20-LFP2	2126243
	<ul style="list-style-type: none"> <li><b>Description:</b> Weld-in flange, hygienic, G 3/4" including acceptance test certificate 3.1, Ra ≤ 0.4 µm</li> <li><b>Material:</b> Stainless steel</li> <li><b>Details:</b> Stainless steel 1.4404</li> </ul>	BEF-HA-SWFL54-LFP2	2122489

	Brief description	Type	part no.
connectors and cables			
	<ul style="list-style-type: none"> <li><b>Connection type head A:</b> Female connector, M12, 5-pin, straight</li> <li><b>Connection type head B:</b> Flying leads</li> <li><b>Signal type:</b> Sensor/actuator cable</li> <li><b>Cable:</b> 2 m, 5-wire, PP</li> <li><b>Description:</b> Sensor/actuator cable, unshielded</li> <li><b>Connection systems:</b> Flying leads</li> <li><b>Note:</b> This product is generally resistant to chemical cleaning agents (see ECOLAB) and other chemical compounds such as H2O2 and CH2O2. Before permanent installation is carried out, the material's resistance to the cleaning agent being used must be checked., Resistant against lactic acid &amp; hydrogen peroxide (H2O2)</li> <li><b>Application:</b> Hygienic and washdown zones, Drag chain operation</li> </ul>	DOL-1205-G02MRN	6058494
	<ul style="list-style-type: none"> <li><b>Connection type head A:</b> Female connector, M12, 5-pin, straight</li> <li><b>Connection type head B:</b> Flying leads</li> <li><b>Signal type:</b> Sensor/actuator cable</li> <li><b>Cable:</b> 5 m, 5-wire, PP</li> <li><b>Description:</b> Sensor/actuator cable, unshielded</li> <li><b>Connection systems:</b> Flying leads</li> <li><b>Note:</b> This product is generally resistant to chemical cleaning agents (see ECOLAB) and other chemical compounds such as H2O2 and CH2O2. Before permanent installation is carried out, the material's resistance to the cleaning agent being used must be checked., Resistant against lactic acid &amp; hydrogen peroxide (H2O2)</li> <li><b>Application:</b> Hygienic and washdown zones, Drag chain operation</li> </ul>	DOL-1205-G05MRN	6058495
	<ul style="list-style-type: none"> <li><b>Connection type head A:</b> Female connector, M12, 5-pin, straight</li> <li><b>Connection type head B:</b> Flying leads</li> <li><b>Signal type:</b> Sensor/actuator cable</li> <li><b>Cable:</b> 10 m, 5-wire, PP</li> <li><b>Description:</b> Sensor/actuator cable, unshielded</li> <li><b>Connection systems:</b> Flying leads</li> <li><b>Note:</b> This product is generally resistant to chemical cleaning agents (see ECOLAB) and other chemical compounds such as H2O2 and CH2O2. Before permanent installation is carried out, the material's resistance to the cleaning agent being used must be checked., Resistant against lactic acid &amp; hydrogen peroxide (H2O2)</li> <li><b>Application:</b> Hygienic and washdown zones, Drag chain operation</li> </ul>	DOL-1205-G10MRN	6058496
	<ul style="list-style-type: none"> <li><b>Connection type head A:</b> Female connector, M12, 5-pin, straight</li> <li><b>Connection type head B:</b> Flying leads</li> <li><b>Signal type:</b> Sensor/actuator cable</li> <li><b>Cable:</b> 25 m, 5-wire, PVC</li> <li><b>Description:</b> Sensor/actuator cable, unshielded</li> <li><b>Connection systems:</b> Flying leads</li> <li><b>Note:</b> This product is generally resistant to chemical cleaning agents (see ECOLAB). Please do not use cleaning agents of any other Kind., Not resistant against lactic acid &amp; hydrogen peroxide (H2O2)</li> <li><b>Application:</b> Hygienic and washdown zones</li> </ul>	DOL-1205-G25MNI	6052628
	<ul style="list-style-type: none"> <li><b>Connection type head A:</b> Female connector, M12, 5-pin, straight</li> <li><b>Connection type head B:</b> Flying leads</li> <li><b>Signal type:</b> Sensor/actuator cable</li> <li><b>Cable:</b> 25 m, 5-wire, PP</li> <li><b>Description:</b> Sensor/actuator cable, unshielded</li> <li><b>Connection systems:</b> Flying leads</li> <li><b>Note:</b> This product is generally resistant to chemical cleaning agents (see ECOLAB) and other chemical compounds such as H2O2 and CH2O2. Before permanent installation is carried out, the material's resistance to the cleaning agent being used must be checked., Resistant against lactic acid &amp; hydrogen peroxide (H2O2)</li> <li><b>Application:</b> Hygienic and washdown zones, Drag chain operation</li> </ul>	DOL-1205-G25MRN	6058497
	<ul style="list-style-type: none"> <li><b>Connection type head A:</b> Female connector, M12, 5-pin, straight</li> <li><b>Connection type head B:</b> Flying leads</li> <li><b>Signal type:</b> Sensor/actuator cable</li> <li><b>Cable:</b> 2 m, 5-wire, PVC</li> <li><b>Description:</b> Sensor/actuator cable, unshielded</li> <li><b>Connection systems:</b> Flying leads</li> <li><b>Note:</b> This product is generally resistant to chemical cleaning agents (see ECOLAB). Please do not use cleaning agents of any other Kind., Not resistant against lactic acid &amp; hydrogen peroxide (H2O2)</li> <li><b>Application:</b> Hygienic and washdown zones</li> </ul>	DOL-1205-G02MNI	6052625
	<ul style="list-style-type: none"> <li><b>Connection type head A:</b> Female connector, M12, 5-pin, straight</li> <li><b>Connection type head B:</b> Flying leads</li> <li><b>Signal type:</b> Sensor/actuator cable</li> <li><b>Cable:</b> 5 m, 5-wire, PVC</li> <li><b>Description:</b> Sensor/actuator cable, unshielded</li> <li><b>Connection systems:</b> Flying leads</li> </ul>	DOL-1205-G05MNI	6052626

	Brief description	Type	part no.
	<ul style="list-style-type: none"> <li><b>Note:</b> This product is generally resistant to chemical cleaning agents (see ECOLAB). Please do not use cleaning agents of any other Kind., Not resistant against lactic acid &amp; hydrogen peroxide (H2O2)</li> <li><b>Application:</b> Hygienic and washdown zones</li> <li><b>Connection type head A:</b> Female connector, M12, 5-pin, straight</li> <li><b>Connection type head B:</b> Flying leads</li> <li><b>Signal type:</b> Sensor/actuator cable</li> <li><b>Cable:</b> 10 m, 5-wire, PVC</li> <li><b>Description:</b> Sensor/actuator cable, unshielded</li> <li><b>Connection systems:</b> Flying leads</li> <li><b>Note:</b> This product is generally resistant to chemical cleaning agents (see ECOLAB). Please do not use cleaning agents of any other Kind., Not resistant against lactic acid &amp; hydrogen peroxide (H2O2)</li> <li><b>Application:</b> Hygienic and washdown zones</li> </ul>	DOL-1205-G10MNI	6052627
	<ul style="list-style-type: none"> <li><b>Connection type head A:</b> Female connector, M12, 5-pin, straight</li> <li><b>Connection type head B:</b> Flying leads</li> <li><b>Signal type:</b> Sensor/actuator cable</li> <li><b>Cable:</b> 20 m, 5-wire, PP</li> <li><b>Description:</b> Sensor/actuator cable, unshielded</li> <li><b>Connection systems:</b> Flying leads</li> <li><b>Note:</b> This product is generally resistant to chemical cleaning agents (see ECOLAB) and other chemical compounds such as H2O2 and CH2O2. Before permanent installation is carried out, the material's resistance to the cleaning agent being used must be checked., Resistant against lactic acid &amp; hydrogen peroxide (H2O2)</li> <li><b>Application:</b> Hygienic and washdown zones, Drag chain operation</li> </ul>	YF2AP5-200PA3XLEAX	2146868
	<ul style="list-style-type: none"> <li><b>Connection type head A:</b> Female connector, M12, 5-pin, straight</li> <li><b>Connection type head B:</b> Flying leads</li> <li><b>Signal type:</b> Sensor/actuator cable</li> <li><b>Cable:</b> 40 m, 5-wire, PP</li> <li><b>Description:</b> Sensor/actuator cable, unshielded</li> <li><b>Connection systems:</b> Flying leads</li> <li><b>Note:</b> This product is generally resistant to chemical cleaning agents (see ECOLAB) and other chemical compounds such as H2O2 and CH2O2. Before permanent installation is carried out, the material's resistance to the cleaning agent being used must be checked., Resistant against lactic acid &amp; hydrogen peroxide (H2O2)</li> <li><b>Application:</b> Hygienic and washdown zones, Drag chain operation</li> </ul>	YF2AP5-400PA3XLEAX	2146869

SpareCruX

## SICK AT A GLANCE

SICK is one of the leading manufacturers of intelligent sensors and sensor solutions for industrial applications. A unique range of products and services creates the perfect basis for controlling processes securely and efficiently, protecting individuals from accidents and preventing damage to the environment.

We have extensive experience in a wide range of industries and understand their processes and requirements. With intelligent sensors, we can deliver exactly what our customers need. In application centers in Europe, Asia and North America, system solutions are tested and optimized in accordance with customer specifications. All this makes us a reliable supplier and development partner.

Comprehensive services complete our offering: SICK LifeTime Services provide support throughout the machine life cycle and ensure safety and productivity.

For us, that is “Sensor Intelligence.”

### WORLDWIDE PRESENCE:

Contacts and other locations – [www.sick.com](http://www.sick.com)

SpareCruX