

SpareCruX

WL9G-3P1132

W9

PHOTOELECTRIC SENSORS

SICK
Sensor Intelligence.



Illustration may differ



Ordering information

| Type | part no. |
|-------------|----------|
| WL9G-3P1132 | 1049081 |

Other models and accessories → www.sick.com/W9

Detailed technical data

Features

| | |
|--|---|
| Functional principle | Photoelectric retro-reflective sensor |
| Functional principle detail | Without reflector minimum distance (autocollimation/coaxial optics) |
| Dimensions (W x H x D) | 12.2 mm x 50 mm x 23.6 mm |
| Housing design (light emission) | Rectangular |
| Mounting hole | M3 |
| Sensing range max. | 0 m ... 5 m ¹⁾ |
| Sensing range | 0 m ... 3 m ¹⁾ |
| Type of light | Visible red light |
| Light source | PinPoint LED ²⁾ |
| Light spot size (distance) | Ø 45 mm (1.5 m) |
| Wave length | 650 nm |
| Adjustment | Single teach-in button |
| AutoAdapt | ✓ |
| Special feature | Detecting transparent objects |
| Special applications | Detecting transparent objects |

¹⁾ Reflector PL80A.

²⁾ Average service life: 100,000 h at T_U = +25 °C.

Mechanics/electronics

| | |
|--|---|
| Supply voltage U_B | 10 V DC ... 30 V DC ¹⁾ |
| Ripple | < 5 V _{pp} ²⁾ |
| Current consumption | 20 mA ³⁾ |
| Switching output | PNP ⁴⁾ |
| Output function | Complementary |
| Switching mode | Light/dark switching ⁴⁾ |
| Output current I_{max} | ≤ 100 mA ⁵⁾ |
| Response time | < 0.5 ms ⁶⁾ |
| Switching frequency | 1,000 Hz ⁷⁾ |
| Connection type | Cable, 4-wire, 2 m ⁸⁾ |
| Cable material | Plastic, PVC |
| Conductor cross section | 0.14 mm ² |
| Circuit protection | A ⁹⁾ B ¹⁰⁾ C ¹¹⁾ |
| Protection class | III |
| Weight | 80 g |
| Polarizing filter | ✓ |
| Housing material | Plastic, VISTAL® |
| Optics material | Plastic, PMMA |
| Enclosure rating | IP66 IP67 IP69K |
| Special feature | Detecting transparent objects |
| Ambient operating temperature | -40 °C ... +60 °C |
| Ambient temperature, storage | -40 °C ... +75 °C |
| UL File No. | NRKH.E181493 |

¹⁾ Limit values when operated in short-circuit protected network: max. 8 A.

²⁾ May not fall below or exceed U_y tolerances.

³⁾ Without load.

⁴⁾ Q = light switching.

⁵⁾ At and above T_u 50 °C, a max. load current of $I_{max} = 50$ mA is permitted.

⁶⁾ Signal transit time with resistive load.

⁷⁾ With light/dark ratio 1:1.

⁸⁾ Do not bend below 0 °C.

⁹⁾ A = V_S connections reverse-polarity protected.

¹⁰⁾ B = inputs and output reverse-polarity protected.

¹¹⁾ C = interference suppression.

Safety-related parameters

| | |
|-------------------------|-------------|
| MTTF_D | 1,232 years |
| DC_{avg} | 0 % |

Certificates

| | |
|-------------------------------------|---|
| EU declaration of conformity | ✓ |
|-------------------------------------|---|

| | |
|--|---|
| UK declaration of conformity | ✓ |
| ACMA declaration of conformity | ✓ |
| Moroccan declaration of conformity | ✓ |
| China RoHS | ✓ |
| ECOLAB certificate | ✓ |
| cULus certificate | ✓ |
| Photobiological safety (DIN EN 62471) certificate | ✓ |

Classifications

| | |
|-----------------------|----------|
| ECLASS 5.0 | 27270902 |
| ECLASS 5.1.4 | 27270902 |
| ECLASS 6.0 | 27270902 |
| ECLASS 6.2 | 27270902 |
| ECLASS 7.0 | 27270902 |
| ECLASS 8.0 | 27270902 |
| ECLASS 8.1 | 27270902 |
| ECLASS 9.0 | 27270902 |
| ECLASS 10.0 | 27270902 |
| ECLASS 11.0 | 27270902 |
| ECLASS 12.0 | 27270902 |
| ETIM 5.0 | EC002717 |
| ETIM 6.0 | EC002717 |
| ETIM 7.0 | EC002717 |
| ETIM 8.0 | EC002717 |
| UNSPSC 16.0901 | 39121528 |

Adjustments Single teach-in button

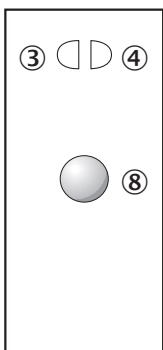

- ③ LED indicator yellow: Status of received light beam
- ④ LED indicator green: power on
- ⑧ Teach-in button

Connection type

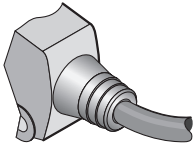

Connection diagram Cd-094

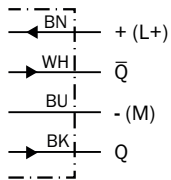

Characteristic curve WL9G-3

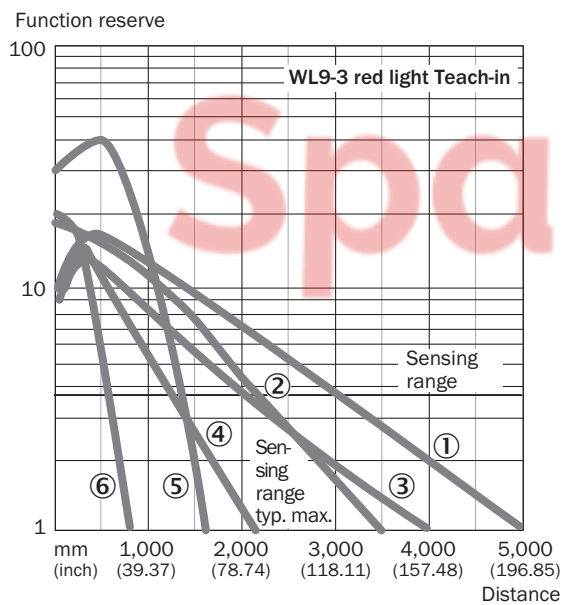

- ① Reflector PL80A
- ② Reflector P250F
- ③ Reflector PL40A
- ④ Reflector PL20F
- ⑤ PL10F reflector
- ⑥ Reflective tape REF-IRF-56

Light spot size

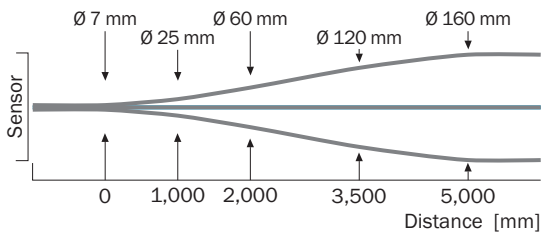

Sensing range diagram WL9G-3

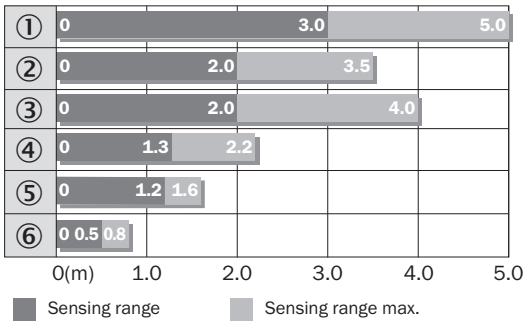

- ① Reflector PL80A
- ② Reflector P250F
- ③ Reflector PL40A
- ④ Reflector PL20F
- ⑤ PL10F reflector
- ⑥ Reflective tape REF-IRF-56





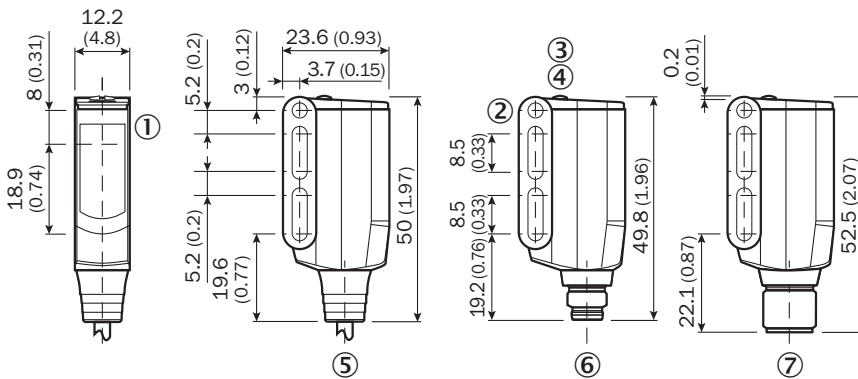

Dimensional drawing WL9-3, WSE9-3



- Dimensions in mm (inch)
- ① Sender and receiver optical axis center
 - ② Mounting hole M3 (Ø 3.1 mm)
 - ③ LED indicator yellow: Status of received light beam
 - ④ LED indicator green: power on
 - ⑤ Connecting cable or connector
 - ⑥ male connector M8, 4-pin
 - ⑦ male connector M12, 4-pin

Recommended accessories

Other models and accessories → www.sick.com/W9

| | Brief description | Type | part no. |
|---|--|--------------|----------|
| Mounting systems | | | |
|  | <ul style="list-style-type: none"> Description: Plate N08 for universal clamp bracket Material: Steel, zinc diecast Details: Zinc plated steel (sheet), Zinc die cast (clamping bracket) Items supplied: Universal clamp (5322626), mounting hardware Usable for: W100, W150, W4S, W4F, W8, W9-3, W8G, W8 Laser, W8 Inox, G6, W100 Laser, W100-2, W10, G6 Inox, RAY10, W4SLG-3, W9, GR18, MultiPulse, Reflex Array, MultiLine, LUT3, KT5, KT8, KT10, CS8 | BEF-KHS-N08 | 2051607 |
|  | <ul style="list-style-type: none"> Description: Mounting bracket Material: Steel Details: Steel, zinc coated Items supplied: Mounting hardware included Suitable for: W9-3 | BEF-WN-W9-2 | 2022855 |
|  | <ul style="list-style-type: none"> Description: Plate N11N for universal clamp bracket Material: Stainless steel Details: Stainless steel 1.4571 (sheet), Stainless steel 1.4408 (clamp) Items supplied: Universal clamp (5322627), mounting hardware Usable for: DeltaPac, Glare, WTD20E | BEF-KHS-N11N | 2071081 |
| reflectors and optics | | | |
|  | <ul style="list-style-type: none"> Description: Fine triple reflector, screw connection, suitable for laser sensors Dimensions: 52 mm 62 mm Ambient operating temperature: -30 °C ... +65 °C | P250F | 5308843 |
| connectors and cables | | | |
|  | <ul style="list-style-type: none"> Connection type head A: Male connector, M12, 4-pin, straight, A-coded Description: Unshielded Connection systems: Screw-type terminals Permitted cross-section: ≤ 0.75 mm² | STE-1204-G | 6009932 |

SICK AT A GLANCE

SICK is one of the leading manufacturers of intelligent sensors and sensor solutions for industrial applications. A unique range of products and services creates the perfect basis for controlling processes securely and efficiently, protecting individuals from accidents and preventing damage to the environment.

We have extensive experience in a wide range of industries and understand their processes and requirements. With intelligent sensors, we can deliver exactly what our customers need. In application centers in Europe, Asia and North America, system solutions are tested and optimized in accordance with customer specifications. All this makes us a reliable supplier and development partner.

Comprehensive services complete our offering: SICK LifeTime Services provide support throughout the machine life cycle and ensure safety and productivity.

For us, that is “Sensor Intelligence.”

WORLDWIDE PRESENCE:

Contacts and other locations – www.sick.com

SpareCruX