



WS/WE12L-2P431

W12

PHOTOELECTRIC SENSORS

SICK
Sensor Intelligence.



Illustration may differ



Ordering information

Type	part no.
WS/WE12L-2P431	1047960

Included in delivery: BEF-KH-W12 (1)

Other models and accessories → www.sick.com/W12

Detailed technical data

Features

Functional principle	Through-beam photoelectric sensor
Sensing range max.	0 m ... 80 m
Emitted beam	
Light source	Laser ¹⁾
Type of light	Visible red light
Light spot size (distance)	Ø 150 mm (60 m)
Key laser figures	
Laser class	1 ^{2) 3)}
Key LED figures	
Wave length	650 nm
Adjustment	Potentiometer
Special features	Laser protection class 1
Special applications	Detecting small objects, Detection of objects moving at high speeds
Items supplied	2 x clamps BEF-KH-W12, incl. screws
Part number of individual components	2051073 WS12L-2D431 2051074 WE12L-2P431

¹⁾ Average service life: 50,000 h at T_U = +25 °C.

²⁾ Pulse length 4 µs, max. pulse power < 5,0 mW.

³⁾ Do not intentionally look into the laser beam. Never point the laser beam at people's eyes.

Safety-related parameters

MTTF_D	440 years
DC_{avg}	0 %

Electronics

Supply voltage U_B	10 V DC ... 30 V DC ¹⁾
Ripple	< 5 V _{pp} ²⁾
Current consumption, sender	≤ 45 mA ³⁾
Current consumption, receiver	≤ 15 mA ³⁾
Protection class	III
Digital output	
Type	PNP
Output current I _{max.}	≤ 100 mA
Response time	≤ 500 μs ⁴⁾
Switching frequency	1,000 Hz ⁵⁾
Circuit protection	A ⁶⁾ C ⁷⁾ D ⁸⁾

¹⁾ Limit values when operated in short-circuit protected network: max. 8 A.

²⁾ May not fall below or exceed U_y tolerances.

³⁾ Without load.

⁴⁾ Signal transit time with resistive load.

⁵⁾ With light/dark ratio 1:1.

⁶⁾ A = V_S connections reverse-polarity protected.

⁷⁾ C = interference suppression.

⁸⁾ D = outputs overcurrent and short-circuit protected.

Mechanics

Housing	Rectangular
Dimensions (W x H x D)	15 mm x 49 mm x 41.5 mm
Connection	Male connector M12, 4-pin
Material	
Housing	Metal
Front screen	Plastic, PMMA
Weight	260 g

Ambient data

Enclosure rating	IP67 IP69K
Ambient operating temperature	-10 °C ... +50 °C
Ambient temperature, storage	-25 °C ... +75 °C
UL File No.	NRKH.E181493 & NRKH7.E181493

Certificates

EU declaration of conformity	✓
UK declaration of conformity	✓
ACMA declaration of conformity	✓
Moroccan declaration of conformity	✓
China RoHS	✓

cULus certificate	✓
Laser safety (IEC 60825-1) certificate	✓

Classifications

ECLASS 5.0	27270901
ECLASS 5.1.4	27270901
ECLASS 6.0	27270901
ECLASS 6.2	27270901
ECLASS 7.0	27270901
ECLASS 8.0	27270901
ECLASS 8.1	27270901
ECLASS 9.0	27270901
ECLASS 10.0	27270901
ECLASS 11.0	27270901
ECLASS 12.0	27270901
ETIM 5.0	EC002716
ETIM 6.0	EC002716
ETIM 7.0	EC002716
ETIM 8.0	EC002716
UNSPSC 16.0901	39121528



Dimensional drawing WL12L-2, WS/WE12L-2

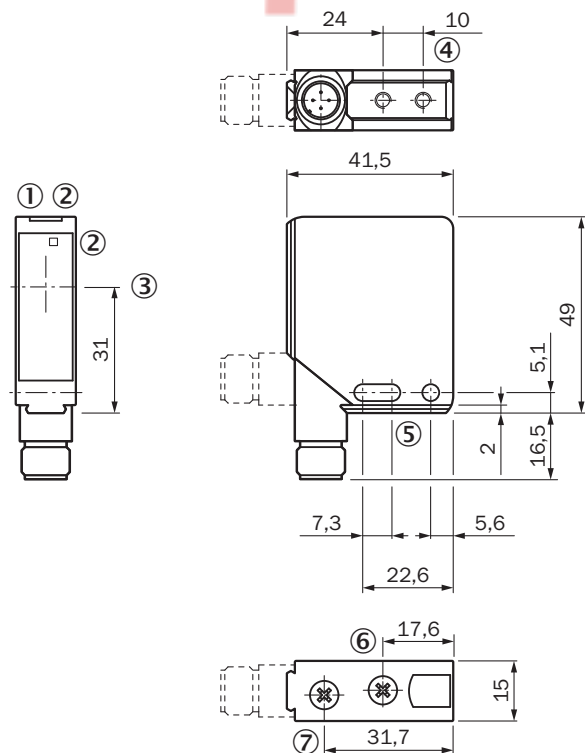

Dimensions in mm (inch)

- ① Operating indicator, green
- ② LED reception indicator, yellow
- ③ Center of optical axis
- ④ M4 threaded mounting hole - 4 mm depth
- ⑤ Mounting hole, Ø 4.2 mm
- ⑥ Focal adjustment
- ⑦ sensitivity control

Adjustments WS/WE12L-2

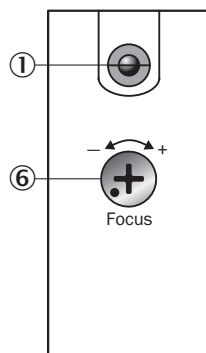

- ① status indicator (WS, top only)
- ⑥ Focal adjustment (WS)

Adjustments

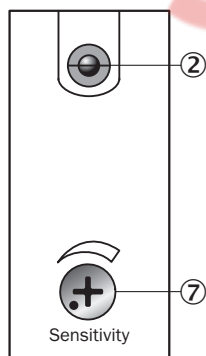

- ② LED signal strength indicator (WE)
- ⑦ Sensitivity adjustment (WE)

Connection type

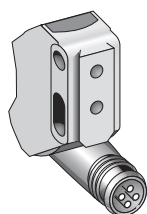

Connection diagram Cd-077

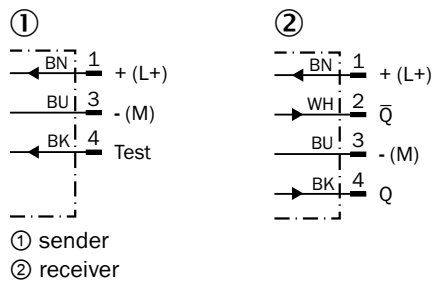

Characteristic curve WS/WE12L-2, 80 m

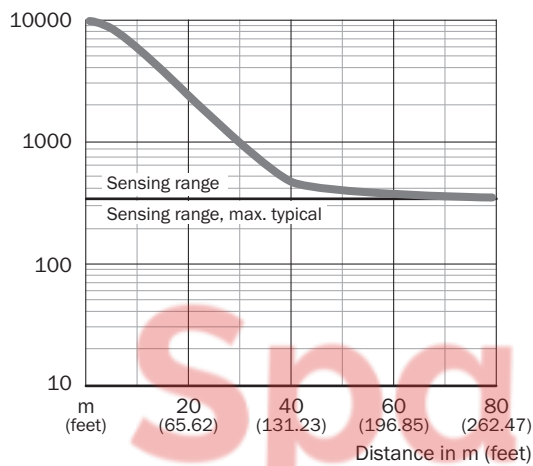



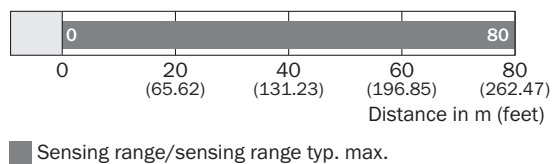

Sensing range diagram WS/WE12L-2, 80 m



Recommended accessories

Other models and accessories → www.sick.com/W12

	Brief description	Type	part no.
Mounting systems			
	<ul style="list-style-type: none"> Description: Mounting bracket, large Material: Stainless steel Details: Stainless steel Items supplied: Mounting hardware included Suitable for: W11-2, W12-3, W16 	BEF-WG-W12	2013942
	<ul style="list-style-type: none"> Description: Plate N11N for universal clamp bracket Material: Stainless steel Details: Stainless steel 1.4571 (sheet), Stainless steel 1.4408 (clamp) Items supplied: Universal clamp (5322627), mounting hardware Usable for: DeltaPac, Glare, WTD20E 	BEF-KHS-N11N	2071081
connectors and cables			
	<ul style="list-style-type: none"> Connection type head A: Female connector, M12, 4-pin, straight, A-coded Connection type head B: Flying leads Signal type: Sensor/actuator cable Cable: 5 m, 4-wire, PVC Description: Sensor/actuator cable, unshielded Application: Zones with chemicals, Uncontaminated zones 	YF2A14-050VB3XLEAX	2096235
	<ul style="list-style-type: none"> Connection type head A: Male connector, M12, 4-pin, straight, A-coded Description: Unshielded Connection systems: Screw-type terminals Permitted cross-section: ≤ 0.75 mm² 	STE-1204-G	6009932
	<ul style="list-style-type: none"> Connection type head A: Female connector, M12, 4-pin, straight, A-coded Connection type head B: Flying leads Signal type: Sensor/actuator cable Cable: 5 m, 4-wire, PUR, halogen-free Description: Sensor/actuator cable, unshielded Application: Uncontaminated zones, Zones with oils and lubricants, Robot, Drag chain operation 	YF2A14-050UB3XLEAX	2095608

SICK AT A GLANCE

SICK is one of the leading manufacturers of intelligent sensors and sensor solutions for industrial applications. A unique range of products and services creates the perfect basis for controlling processes securely and efficiently, protecting individuals from accidents and preventing damage to the environment.

We have extensive experience in a wide range of industries and understand their processes and requirements. With intelligent sensors, we can deliver exactly what our customers need. In application centers in Europe, Asia and North America, system solutions are tested and optimized in accordance with customer specifications. All this makes us a reliable supplier and development partner.

Comprehensive services complete our offering: SICK LifeTime Services provide support throughout the machine life cycle and ensure safety and productivity.

For us, that is “Sensor Intelligence.”

WORLDWIDE PRESENCE:

Contacts and other locations – www.sick.com

SpareCruX