



# DS50-N1112

Dx50

TIME-OF-FLIGHT SENSORS

**SICK**  
Sensor Intelligence.



### Ordering information

Type	part no.
DS50-N1112	1047404

Other models and accessories → [www.sick.com/Dx50](http://www.sick.com/Dx50)



### Detailed technical data

#### Features

<b>Measuring range</b>	200 mm ... 10,000 mm, 90% remission factor 200 mm ... 6,000 mm, 18% reflection factor 200 mm ... 4,000 mm, 6% remission factor
<b>Target</b>	Natural objects
<b>Resolution</b>	1,000 µm ... 1 mm <sup>1)</sup>
<b>Repeatability</b>	≥ 2.5 mm <sup>2) 3) 4)</sup>
<b>Measurement accuracy</b>	± 10 mm <sup>1) 5)</sup>
<b>Response time</b>	10 ms ... 50 ms, 10 ms / 50 ms <sup>4)</sup>
<b>Switching frequency</b>	50 Hz / 10 Hz <sup>4)</sup>
<b>Emitted beam</b>	
Light source	Laser, red <sup>6)</sup>
Type of light	Visible red light
Typ. light spot size (distance)	15 mm x 15 mm (10 m)
<b>Key laser figures</b>	
Normative reference	IEC 60825-1:2014, EN 60825-1:2014
Laser class	2 <sup>6)</sup>
Average laser service life (at 25 °C)	100,000 h
<b>Additional function</b>	Set moving average: fast/slow Adjustable operating modes: Switching point (Dt0) / Switching window/Background (ObSB) Teach-in, scaling and inversion of digital output Set hysteresis

<sup>1)</sup> Related to distance value on the display.

<sup>2)</sup> Equivalent to 1 σ.

<sup>3)</sup> 6% ... 90% remission factor.

<sup>4)</sup> Dependent on the averaging setting: fast/slow.

<sup>5)</sup> 90% remission factor.

<sup>6)</sup> Wavelength: 658 nm; max. output: 180 mW; pulse duration: 5 ns; duty cycle: 1/200.

		Multifunctional input: laser off / external teach / deactivated Unique measurement value Crosstalk safety Switch-off display Reset to factory default Lock user interface
<b>Safety-related parameters</b>	MTTF <sub>D</sub>	101 years
	DC <sub>avg</sub>	0%

- 1) Related to distance value on the display.
- 2) Equivalent to 1  $\sigma$ .
- 3) 6% ... 90% remission factor.
- 4) Dependent on the averaging setting: fast/slow.
- 5) 90% remission factor.
- 6) Wavelength: 658 nm; max. output: 180 mW; pulse duration: 5 ns; duty cycle: 1/200.

## Interfaces

<b>Digital output</b>	Number	2 <sup>1) 2)</sup>
	Type	NPN
	Maximum output current I <sub>A</sub>	≤ 100 mA
<b>Multifunctional input (MF)</b>		1 x <sup>3) 4)</sup>
<b>Hysteresis</b>		1 mm ... 9,999 mm

- 1) Output Q short-circuit protected.
- 2) NPN: HIGH = < 2.5 V / LOW = V<sub>S</sub>.
- 3) Response time ≤ 60 ms.
- 4) NPN: HIGH = ≤ 2.5 V / LOW = V<sub>S</sub>.

## Electronics

<b>Supply voltage U<sub>B</sub></b>	DC 10 V ... 30 V <sup>1)</sup>
<b>Power consumption</b>	≤ 1.85 W <sup>2)</sup>
<b>Ripple</b>	≤ 5 V <sub>pp</sub> <sup>3)</sup>
<b>Initialization time</b>	≤ 350 ms
<b>Warm-up time</b>	≤ 15 min
<b>Display</b>	LC display, 2 x LED
<b>Enclosure rating</b>	IP65
<b>Protection class</b>	III
<b>Connection type</b>	Male connector

- 1) Limit values, reverse-polarity protected, operation in short-circuit protected network: max. 8 A.
- 2) Without load.
- 3) May not fall short of or exceed V<sub>S</sub> tolerances.

## Mechanics

<b>Dimensions (W x H x D)</b>	36.1 mm x 62.7 mm x 57.7 mm
<b>Housing material</b>	Metal (zinc diecast)
<b>Window material</b>	Plastic (PMMA)

<b>Weight</b>	200 g
---------------	-------

Ambient data

<b>Ambient temperature, operation</b>	-30 °C ... +65 °C -30 °C ... +80 °C, operation with 2 cooling plates -30 °C ... +140 °C, operation with 2 cooling plates and protection filter
<b>Ambient temperature, storage</b>	-40 °C ... +75 °C
<b>Max. rel. humidity (not condensing)</b>	≤ 95 %
<b>Typ. Ambient light immunity</b>	40,000 lx
<b>Vibration resistance</b>	EN 60068-2-6, EN 60068-2-64
<b>Shock resistance</b>	EN 60068-2-27

Classifications

<b>ECLASS 5.0</b>	27270801
<b>ECLASS 5.1.4</b>	27270801
<b>ECLASS 6.0</b>	27270801
<b>ECLASS 6.2</b>	27270801
<b>ECLASS 7.0</b>	27270801
<b>ECLASS 8.0</b>	27270801
<b>ECLASS 8.1</b>	27270801
<b>ECLASS 9.0</b>	27270801
<b>ECLASS 10.0</b>	27270801
<b>ECLASS 11.0</b>	27270801
<b>ECLASS 12.0</b>	27270916
<b>ETIM 5.0</b>	EC001825
<b>ETIM 6.0</b>	EC001825
<b>ETIM 7.0</b>	EC001825
<b>ETIM 8.0</b>	EC001825
<b>UNSPSC 16.0901</b>	41111613

Dimensional drawing

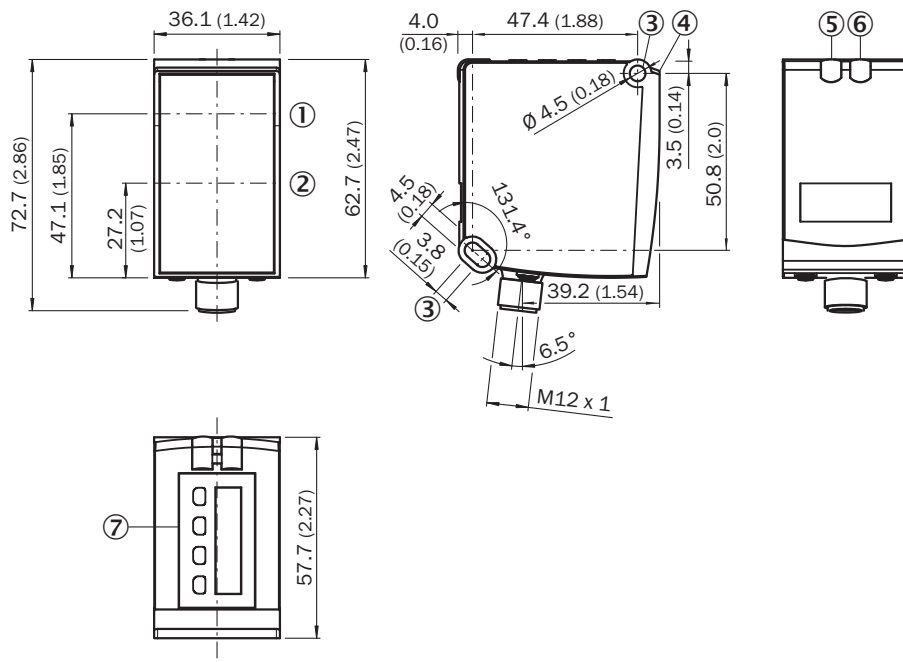

Dimensions in mm (inch)

- ① optical axis, sender
- ② optical axis, receiver
- ③ fixing hole
- ④ Reference surface = 0 mm
- ⑤ Status indicator digital output Q<sub>1</sub> (orange)
- ⑥ DT50/DT50 Hi/DL50: Status display for supply voltage active (green), DS50/DL50 Hi: Status display of digital output Q<sub>2</sub> (orange)
- ⑦ Control elements and display

Connection type Plug, M12, 5-pin

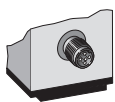

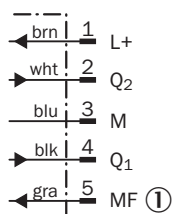

Connection diagram







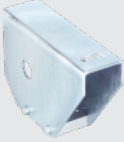

① Multifunctional input (MF)

Recommended accessories

Other models and accessories → [www.sick.com/Dx50](http://www.sick.com/Dx50)

	Brief description	Type	part no.
device protection and care			
	<ul style="list-style-type: none"> <li><b>Description:</b> Weather Cover for Dx35/Dx50/Dx50-2/Dx80</li> </ul>	OBW-KHS-M02	2050205
	<ul style="list-style-type: none"> <li><b>Description:</b> Cooling plate for Dx50/Dx50-2/DT20 (for water cooling)</li> <li><b>Usable for:</b> DT20 Hi, Dx50, Dx50-2</li> </ul>	BEF-KP-Dx50/DT20	2055755
	Strich		On request
Mounting systems			
	<ul style="list-style-type: none"> <li><b>Description:</b> Mounting bracket, steel, zinc coated</li> <li><b>Material:</b> Steel</li> <li><b>Details:</b> Steel, zinc coated</li> <li><b>Items supplied:</b> Mounting hardware for the sensor included</li> <li><b>Suitable for:</b> Dx50, Dx80, Dx50, Dx80</li> </ul>	BEF-WN-DX50	2048370



	Brief description	Type	part no.
connectors and cables			
	<ul style="list-style-type: none"> <li>• <b>Connection type head A:</b> Female connector, M12, 5-pin, angled, A-coded</li> <li>• <b>Connection type head B:</b> Flying leads</li> <li>• <b>Signal type:</b> Sensor/actuator cable</li> <li>• <b>Cable:</b> 2 m, 5-wire, PVC</li> <li>• <b>Description:</b> Sensor/actuator cable, unshielded</li> <li>• <b>Application:</b> Zones with chemicals, Uncontaminated zones</li> </ul>	YG2A15-020VB5XLEAX	2096215
	<ul style="list-style-type: none"> <li>• <b>Connection type head A:</b> Female connector, M12, 5-pin, straight, A-coded</li> <li>• <b>Connection type head B:</b> Flying leads</li> <li>• <b>Signal type:</b> Sensor/actuator cable</li> <li>• <b>Cable:</b> 2 m, 5-wire, PUR, halogen-free</li> <li>• <b>Description:</b> Sensor/actuator cable, unshielded</li> <li>• <b>Application:</b> Uncontaminated zones, Zones with oils and lubricants, Robot, Drag chain operation</li> </ul>	YF2A15-020UB5XLEAX	2095617
	<ul style="list-style-type: none"> <li>• <b>Connection type head A:</b> Female connector, M12, 5-pin, straight, A-coded</li> <li>• <b>Connection type head B:</b> Flying leads</li> <li>• <b>Signal type:</b> Sensor/actuator cable</li> <li>• <b>Cable:</b> 2 m, 5-wire, PVC</li> <li>• <b>Description:</b> Sensor/actuator cable, unshielded</li> <li>• <b>Application:</b> Zones with chemicals, Uncontaminated zones</li> </ul>	YF2A15-020VB5XLEAX	2096239
	<ul style="list-style-type: none"> <li>• <b>Connection type head A:</b> Female connector, M12, 5-pin, angled, A-coded</li> <li>• <b>Connection type head B:</b> Flying leads</li> <li>• <b>Signal type:</b> Sensor/actuator cable</li> <li>• <b>Cable:</b> 0.6 m, 5-wire, PVC</li> <li>• <b>Description:</b> Sensor/actuator cable, unshielded</li> <li>• <b>Application:</b> Zones with chemicals, Uncontaminated zones</li> </ul>	YG2A15-C60VB5XLEAX	2145573
	<ul style="list-style-type: none"> <li>• <b>Connection type head A:</b> Female connector, M12, 5-pin, angled, A-coded</li> <li>• <b>Connection type head B:</b> Flying leads</li> <li>• <b>Signal type:</b> Sensor/actuator cable</li> <li>• <b>Cable:</b> 1 m, 5-wire, PVC</li> <li>• <b>Description:</b> Sensor/actuator cable, unshielded</li> <li>• <b>Application:</b> Zones with chemicals, Uncontaminated zones</li> </ul>	YG2A15-010VB5XLEAX	2145574
	<ul style="list-style-type: none"> <li>• <b>Connection type head A:</b> Female connector, M12, 5-pin, angled, A-coded</li> <li>• <b>Connection type head B:</b> Flying leads</li> <li>• <b>Signal type:</b> Sensor/actuator cable</li> <li>• <b>Cable:</b> 3 m, 5-wire, PVC</li> <li>• <b>Description:</b> Sensor/actuator cable, unshielded</li> <li>• <b>Application:</b> Zones with chemicals, Uncontaminated zones</li> </ul>	YG2A15-030VB5XLEAX	2145575
	<ul style="list-style-type: none"> <li>• <b>Connection type head A:</b> Female connector, M12, 5-pin, straight, A-coded</li> <li>• <b>Connection type head B:</b> Flying leads</li> <li>• <b>Signal type:</b> Sensor/actuator cable</li> <li>• <b>Cable:</b> 0.6 m, 5-wire, PVC</li> <li>• <b>Description:</b> Sensor/actuator cable, unshielded</li> <li>• <b>Application:</b> Zones with chemicals, Uncontaminated zones</li> </ul>	YF2A15-C60VB5XLEAX	2145570
	<ul style="list-style-type: none"> <li>• <b>Connection type head A:</b> Female connector, M12, 5-pin, straight, A-coded</li> <li>• <b>Connection type head B:</b> Flying leads</li> <li>• <b>Signal type:</b> Sensor/actuator cable</li> <li>• <b>Cable:</b> 3 m, 5-wire, PVC</li> <li>• <b>Description:</b> Sensor/actuator cable, unshielded</li> <li>• <b>Application:</b> Zones with chemicals, Uncontaminated zones</li> </ul>	YF2A15-030VB5XLEAX	2145572

## SICK AT A GLANCE

SICK is one of the leading manufacturers of intelligent sensors and sensor solutions for industrial applications. A unique range of products and services creates the perfect basis for controlling processes securely and efficiently, protecting individuals from accidents and preventing damage to the environment.

We have extensive experience in a wide range of industries and understand their processes and requirements. With intelligent sensors, we can deliver exactly what our customers need. In application centers in Europe, Asia and North America, system solutions are tested and optimized in accordance with customer specifications. All this makes us a reliable supplier and development partner.

Comprehensive services complete our offering: SICK LifeTime Services provide support throughout the machine life cycle and ensure safety and productivity.

For us, that is “Sensor Intelligence.”

### WORLDWIDE PRESENCE:

Contacts and other locations – [www.sick.com](http://www.sick.com)

SpareCruX