



WS/WE45-R260

W45

PHOTOELECTRIC SENSORS

SICK
Sensor Intelligence.



Ordering information

Type	part no.
WS/WE45-R260	1010995

Other models and accessories → www.sick.com/W45

Illustration may differ



Detailed technical data

Features

Functional principle	Through-beam photoelectric sensor
Dimensions (W x H x D)	60 mm x 105 mm x 105 mm
Housing design (light emission)	Rectangular
Sensing range max.	0 m ... 350 m
Sensing range	0 m ... 300 m
Focus	Approx. 0.9°
Type of light	Infrared light
Light source	LED ¹⁾
Light spot size (distance)	Ø 4.5 m (300 m)
Angle of dispersion	Approx. 0.9°
Adjustment	Potentiometer
Special features	Pulsating Cable gland, for cross-section: 0,14 mm ² ... 2,5 mm ² , max. 16 A

¹⁾ Average service life: 100,000 h at T_J = +25 °C.

Mechanics/electronics

Supply voltage U_B	20 V AC/DC ... 250 V AC/DC ¹⁾
Power consumption, sender	≤ 3 VA
Power consumption, receiver	≤ 3 VA
Switching output	Relay, electrically isolated ²⁾

¹⁾ Limit values, cross-section: 0,14 mm² ... 2,5 mm², max. 16 A.

²⁾ Provide suitable spark suppression for inductive or capacitive loads.

³⁾ With light/dark ratio 1:1.

⁴⁾ A = V_S connections reverse-polarity protected.

⁵⁾ C = interference suppression.

⁶⁾ Up to 140 °C with cooling plates (see accessories).

Output function	Change-over contacts
Switching mode	Light/dark switching ²⁾
Switching mode selector	Selectable via time delay selector switch
Switching current (switching voltage)	4 A @ 250 V AC, 4 A @ 24 V DC, 0.125 A @ 120 V DC UL: 4 A @ 250 V AC, general purpose / 2 A @ 250 V AC, pilot duty
Response time	≤ 10 ms
Switching frequency	10 Hz ³⁾
Time functions	Switch-on delay Off delay ON and OFF delay
Delay time	Adjustable via time delay selector switch, 0.5 s ... 12 s
Connection type	Terminal connection with PG13,5, 6-pin
Circuit protection	A ⁴⁾ C ⁵⁾
Protection class	I
Weight	1,600 g
Housing material	Metal
Enclosure rating	IP67
Usage category	AC-15, DC-13 According to EN 60947-1
Ambient operating temperature	-25 °C ... +55 °C ⁶⁾
Ambient temperature, storage	-40 °C ... +70 °C
UL File No.	NRKH.E181493 & NRKH7.E181493
Part number of individual components	1009409 WS45-U260 1009411 WE45-R260

¹⁾ Limit values, cross-section: 0,14 mm² ... 2,5 mm², max. 16 A.

²⁾ Provide suitable spark suppression for inductive or capacitive loads.

³⁾ With light/dark ratio 1:1.

⁴⁾ A = V_S connections reverse-polarity protected.

⁵⁾ C = interference suppression.

⁶⁾ Up to 140 °C with cooling plates (see accessories).

Safety-related parameters

MTTF_D	376 years
DC_{avg}	0 %

Certificates

EU declaration of conformity	✓
UK declaration of conformity	✓
ACMA declaration of conformity	✓
Moroccan declaration of conformity	✓
China RoHS	✓
CCC certificate	✓
cULus certificate	✓
Photobiological safety (DIN EN 62471) certificate	✓

Classifications

ECLASS 5.0	27270901
ECLASS 5.1.4	27270901
ECLASS 6.0	27270901
ECLASS 6.2	27270901
ECLASS 7.0	27270901
ECLASS 8.0	27270901
ECLASS 8.1	27270901
ECLASS 9.0	27270901
ECLASS 10.0	27270901
ECLASS 11.0	27270901
ECLASS 12.0	27270901
ETIM 5.0	EC002716
ETIM 6.0	EC002716
ETIM 7.0	EC002716
ETIM 8.0	EC002716
UNSPSC 16.0901	39121528

Adjustments

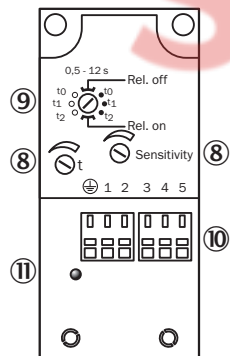

- ⑦ sensitivity control
- ⑧ Time control
- ⑨ time delay selector switch
- ⑩ terminal strip
- ⑪ Status indicator

Connection type

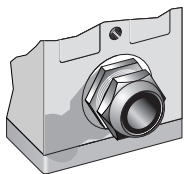

Connection diagram Cd-168

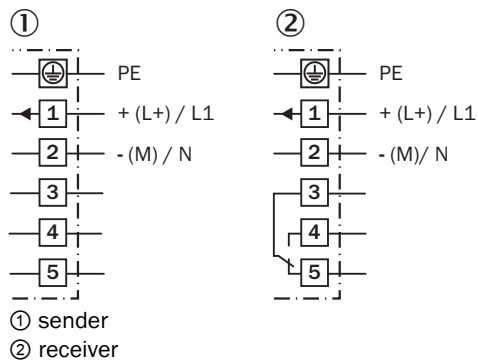

Characteristic curve

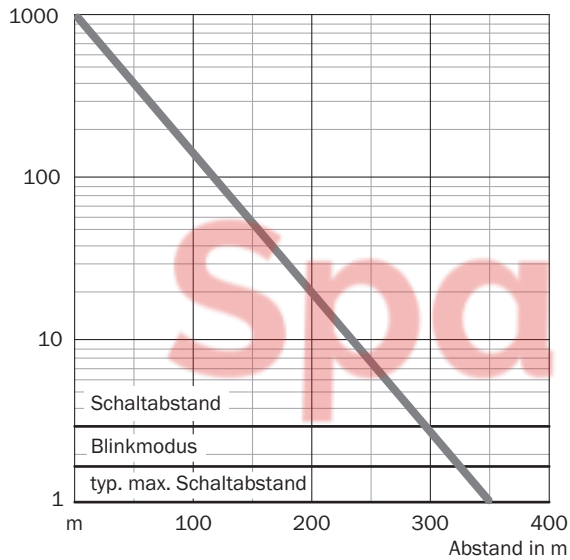

Sensing range diagram

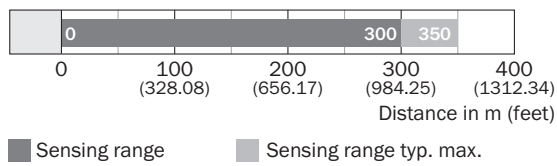

Dimensional drawing

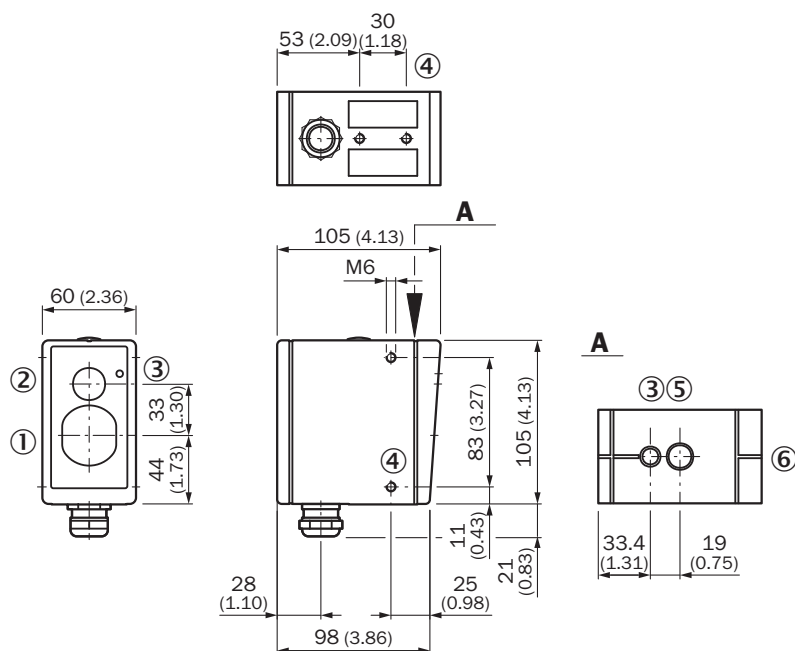

Dimensions in mm (inch)

- ① Center of optical axis, sender (WS),
- ② Center of optical axis, receiver (WE)
- ② View finder lens
- ③ LED signal strength indicator
- ④ M6 threaded mounting hole, 8 mm deep
- ⑤ Eyepiece for alignment aid
- ⑥ Alignment sight

Recommended accessories

Other models and accessories → www.sick.com/W45

	Brief description	Type	part no.
Mounting systems			
	<ul style="list-style-type: none"> • Description: Mounting bracket • Material: Steel • Details: Steel, zinc coated • Items supplied: Mounting hardware included 	BEF-WN-W45	2011480

SICK AT A GLANCE

SICK is one of the leading manufacturers of intelligent sensors and sensor solutions for industrial applications. A unique range of products and services creates the perfect basis for controlling processes securely and efficiently, protecting individuals from accidents and preventing damage to the environment.

We have extensive experience in a wide range of industries and understand their processes and requirements. With intelligent sensors, we can deliver exactly what our customers need. In application centers in Europe, Asia and North America, system solutions are tested and optimized in accordance with customer specifications. All this makes us a reliable supplier and development partner.

Comprehensive services complete our offering: SICK LifeTime Services provide support throughout the machine life cycle and ensure safety and productivity.

For us, that is “Sensor Intelligence.”

WORLDWIDE PRESENCE:

Contacts and other locations – www.sick.com

SpareCruX