



# WTB26I-24161120A00

W26

PHOTOELECTRIC SENSORS

**SICK**  
Sensor Intelligence.



Illustration may differ

Ordering information

| Type               | part no. |
|--------------------|----------|
| WTB26I-24161120A00 | 1218667  |

Other models and accessories → [www.sick.com/W26](http://www.sick.com/W26)



Detailed technical data

Features

|   |   |
|---|---|
| <b>Functional principle</b>   | Photoelectric proximity sensor  |
| <b>Functional principle detail</b>  | Background suppression  |
| <b>Sensing range</b>  |   |
| Sensing range min.  | 30 mm   |
| Sensing range max.  | 2,000 mm  |
| Adjustable switching threshold for background suppression                                       | 180 mm ... 2,000 mm   |
| Reference object  | Object with 90% remission factor (complies with standard white according to DIN 5033) |
| Minimum distance between set sensing range and background (black 6% / white 90%)                | 85 mm, at a distance of 800 mm  |
| Recommended sensing range for the best performance  | 200 mm ... 800 mm   |
| <b>Emitted beam</b>   |   |
| Light source  | LED   |
| Type of light   | Infrared light  |
| Shape of light spot   | Point-shaped  |
| Light spot size (distance)  | Ø 14 mm (1,000 mm)  |
| Maximum dispersion of the emitted beam around the standardized transmission axis (squint angle) | < +/- 1.0° (at Ta = +23 °C)   |
| <b>Key LED figures</b>  |   |

|                        |  |
|------------------------|--|
| Normative reference    | EN 62471:2008-09   IEC 62471:2006, modified  |
| LED risk group marking | Free group   |
| Wave length            | 850 nm   |
| Average service life   | 100,000 h at $T_a = +25 \text{ }^\circ\text{C}$  |
| <b>Adjustment</b>      |  |
| Teach-Turn adjustment  | BluePilot: For setting the sensing range   |
| IO-Link                | For configuring the sensor parameters and Smart Task functions                               |
| <b>Display</b>         |  |
| LED blue               | BluePilot: sensing range indicator   |
| LED green              | Operating indicator<br>Static on: power on<br>Flashing: IO-Link mode                         |
| LED yellow             | Status of received light beam<br>Static on: object present<br>Static off: object not present |

## Safety-related parameters

|                                     |           |
|-------------------------------------|-----------|
| <b>MTTF<sub>D</sub></b>             | 626 years |
| <b>DC<sub>avg</sub></b>             | 0%        |
| <b>T<sub>M</sub> (mission time)</b> | 20 years  |

## Communication interface

|                             |  |
|-----------------------------|--|
| <b>IO-Link</b>              | ✓, V1.1  |
| Data transmission rate      | COM2 (38,4 kBaud)  |
| Cycle time                  | 2.3 ms   |
| Process data length         | 16 Bit   |
| Process data structure      | Bit 0 = switching signal Q <sub>L1</sub><br>Bit 1 = switching signal Q <sub>L2</sub><br>Bit 2 ... 15 = empty |
| VendorID                    | 26   |
| DeviceID HEX                | 0x800184   |
| DeviceID DEC                | 8388996  |
| Compatible master port type | A  |
| SIO mode support            | Yes  |

## Electronics

|                                     |  |
|-------------------------------------|--|
| <b>Supply voltage U<sub>B</sub></b> | 10 V DC ... 30 V DC <sup>1)</sup>                                      |
| <b>Ripple</b>                       | ≤ 5 V <sub>pp</sub>  |
| <b>Usage category</b>               | DC-12 (According to EN 60947-5-2)<br>DC-13 (According to EN 60947-5-2) |
| <b>Current consumption</b>          | ≤ 30 mA, without load. At U <sub>B</sub> = 24 V                        |
| <b>Protection class</b>             | III  |
| <b>Digital output</b>               |  |

<sup>1)</sup> Limit values.

<sup>2)</sup> Signal transit time with resistive load in switching mode.

<sup>3)</sup> With light/dark ratio 1:1.

<sup>4)</sup> This switching output must not be connected to another output.

|                                       |   |
|---------------------------------------|---|
| Number                                | 2 (Complementary)   |
| Type                                  | Push-pull: PNP/NPN  |
| Switching mode                        | Light/dark switching  |
| Signal voltage PNP HIGH/LOW           | Approx. $U_B - 2.5 \text{ V} / 0 \text{ V}$   |
| Signal voltage NPN HIGH/LOW           | Approx. $U_B / < 2.5 \text{ V}$   |
| Output current $I_{\max}$             | $\leq 100 \text{ mA}$   |
| Circuit protection outputs            | Reverse polarity protected<br>Overcurrent and short-circuit protected   |
| Response time                         | $\leq 500 \mu\text{s}$ <sup>2)</sup>  |
| Repeatability (response time)         | 150 $\mu\text{s}$   |
| Switching frequency                   | 1,000 Hz <sup>3)</sup>  |
| <b>Pin/Wire assignment</b>            |   |
| Function of pin 4/black (BK)          | Digital output, light switching, object present → output $Q_{L1}$ HIGH; IO-Link communication C <sup>4)</sup> |
| Function of pin 4/black (BK) – detail | The pin 4 function of the sensor can be configured<br>Additional possible settings via IO-Link                |
| Function of pin 2/white (WH)          | Digital output, dark switching, object present → output $\bar{Q}_{L1}$ LOW <sup>4)</sup>                      |
| Function of pin 2/white (WH) – detail | The pin 2 function of the sensor can be configured<br>Additional possible settings via IO-Link                |

<sup>1)</sup> Limit values.

<sup>2)</sup> Signal transit time with resistive load in switching mode.

<sup>3)</sup> With light/dark ratio 1:1.

<sup>4)</sup> This switching output must not be connected to another output.

## Mechanics

|   |                             |
|---|-----------------------------|
| <b>Housing</b>  | Rectangular                 |
| <b>Dimensions (W x H x D)</b>                         | 24.6 mm x 82.5 mm x 53.3 mm |
| <b>Connection</b>                                     | Male connector M12, 4-pin   |
| <b>Material</b>                                       |                             |
| Housing   | Plastic, VISTAL®            |
| Front screen  | Plastic, PMMA               |
| Male connector  | Plastic, VISTAL®            |
| <b>Weight</b>   | Approx. 80 g                |
| <b>Maximum tightening torque of the fixing screws</b> | 1.3 Nm                      |

## Ambient data

|                                      |   |
|--------------------------------------|---|
| <b>Enclosure rating</b>              | IP66 (EN 60529)<br>IP67 (EN 60529)<br>IP69 (EN 60529) <sup>1)</sup>   |
| <b>Ambient operating temperature</b> | -40 °C ... +60 °C   |
| <b>Ambient temperature, storage</b>  | -40 °C ... +75 °C   |
| <b>Shock resistance</b>              | 50 g, 11 ms (25 positive and 25 negative shocks per axis, for X, Y, Z axes, 150 shocks in total (EN60068-2-27)) |

<sup>1)</sup> Replaces IP69K with ISO 20653: 2013-03.

|  |   |
|--|---|
|  | 50 g, 6 ms (5,000 positive and 5,000 negative shocks per axis, for X, Y, Z axes, 30,000 shocks in total (EN60068-2-27)) |
| <b>Vibration resistance</b>                | 10 Hz ... 2,000 Hz (Amplitude 0.5 mm / 10 g, 20 sweeps per axis, for X, Y, Z axes, 1 octave/min, (EN60068-2-6))         |
| <b>Air humidity</b>                        | 35 % ... 95 %, relative humidity (no condensation)  |
| <b>Electromagnetic compatibility (EMC)</b> | EN 60947-5-2  |
| <b>Resistance to cleaning agent</b>        | ECOLAB  |
| <b>UL File No.</b>                         | NRKH.E181493 & NRKH7.E181493  |

<sup>1)</sup> Replaces IP69K with ISO 20653: 2013-03.

### Smart Task

|                                  |   |
|----------------------------------|---|
| <b>Smart Task name</b>           | Base logics   |
| <b>Logic function</b>            | Direct<br>AND<br>OR<br>Window<br>Hysteresis   |
| <b>Timer function</b>            | Deactivated<br>Switch-on delay<br>Off delay<br>ON and OFF delay<br>Impulse (one shot) |
| <b>Inverter</b>                  | Yes   |
| <b>Switching frequency</b>       | SIO Logic: 800 Hz <sup>1)</sup><br>IOL: 650 Hz <sup>2)</sup>                          |
| <b>Response time</b>             | SIO Logic: 600 µs <sup>1)</sup><br>IOL: 750 µs <sup>2)</sup>                          |
| <b>Repeatability</b>             | SIO Logic: 300 µs <sup>1)</sup><br>IOL: 400 µs <sup>2)</sup>                          |
| <b>Switching signal</b>          |   |
| Switching signal Q <sub>L1</sub> | Switching output  |
| Switching signal $\bar{Q}_{L1}$  | Switching output  |

<sup>1)</sup> Use of Smart Task functions without IO-Link communication (SIO mode).

<sup>2)</sup> Use of Smart Task functions with IO-Link communication function.

### Diagnosis

|                         |     |
|-------------------------|-----|
| <b>Device status</b>    | Yes |
| <b>Quality of teach</b> | Yes |

### Certificates

|   |   |
|---|---|
| <b>EU declaration of conformity</b>       | ✓ |
| <b>UK declaration of conformity</b>       | ✓ |
| <b>ACMA declaration of conformity</b>     | ✓ |
| <b>Moroccan declaration of conformity</b> | ✓ |
| <b>China RoHS</b>                         | ✓ |
| <b>ECOLAB certificate</b>                 | ✓ |
| <b>cULus certificate</b>                  | ✓ |
| <b>IO-Link certificate</b>                | ✓ |

|   |   |
|---|---|
| Photobiological safety (DIN EN 62471) certificate                     | ✓ |
| Information according to Art. 3 of Data Act (Regulation EU 2023/2854) | ✓ |

Classifications

|                |          |
|----------------|----------|
| ECLASS 5.0     | 27270904 |
| ECLASS 5.1.4   | 27270904 |
| ECLASS 6.0     | 27270904 |
| ECLASS 6.2     | 27270904 |
| ECLASS 7.0     | 27270904 |
| ECLASS 8.0     | 27270904 |
| ECLASS 8.1     | 27270904 |
| ECLASS 9.0     | 27270904 |
| ECLASS 10.0    | 27270904 |
| ECLASS 11.0    | 27270904 |
| ECLASS 12.0    | 27270903 |
| ETIM 5.0       | EC002719 |
| ETIM 6.0       | EC002719 |
| ETIM 7.0       | EC002719 |
| ETIM 8.0       | EC002719 |
| UNSPSC 16.0901 | 39121528 |



Dimensional drawing, sensor

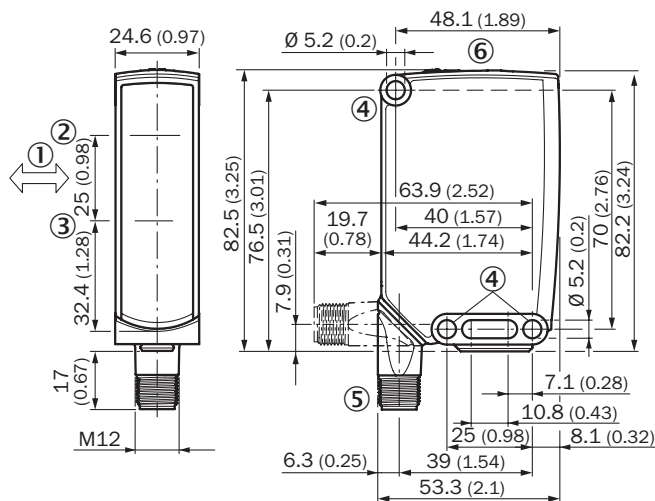

Dimensions in mm (inch)

- ① Standard direction of the material being detected
- ② Center of optical axis, sender
- ③ Center of optical axis, receiver
- ④ Mounting hole, Ø 5.2 mm
- ⑤ Connection
- ⑥ display and adjustment elements

display and adjustment elements



- ① LED indicator green
- ② LED indicator yellow
- ③ Teach-Turn adjustment
- ④ LED blue

Connection type M12 male connector, 4-pin

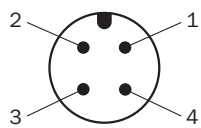

Connection diagram Cd-390



Truth table Push-pull: PNP/NPN - light switching Q

|                         | Light switching Q (normally open (upper switch), normally closed (lower switch)) |                              |
|-------------------------|--|------------------------------|
|                         | Object not present → Output LOW  | Object present → Output HIGH |
| Light receive           | ✗  | ✓                            |
| Light receive indicator | ✗  | ☀                            |
| Load resistance to L+   | ⚡  | ✗                            |
| Load resistance to M    | ✗  | ⚡                            |
|                         |  |                              |

Truth table Push-pull: PNP/NPN - dark switching  $\bar{Q}$

|                         | Dark switching $\bar{Q}$ (normally closed (upper switch), normally open (lower switch)) |                             |
|-------------------------|---|-----------------------------|
|                         | Object not present → Output HIGH  | Object present → Output LOW |
| Light receive           | ✗   | ✓                           |
| Light receive indicator | ✗   | ☀                           |
| Load resistance to L+   | ✗   | ⚡                           |
| Load resistance to M    | ⚡   | ✗                           |
|                         |   |                             |

Characteristic curve WTB26I-xxxx1xx

Minimum distance in mm (y) between the set sensing range and white background (90 % remission)

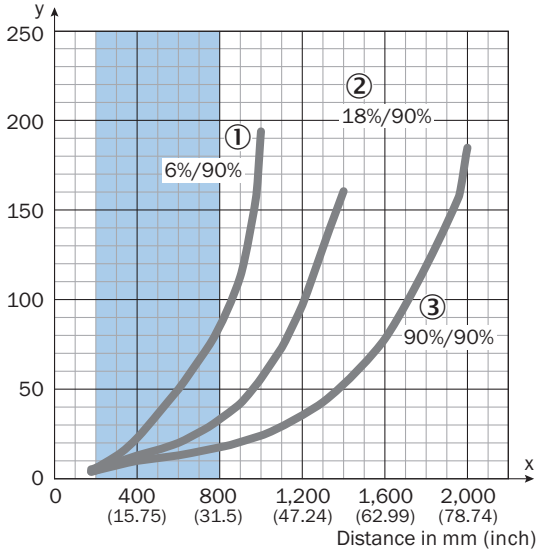

Example:  
Safe suppression of the background

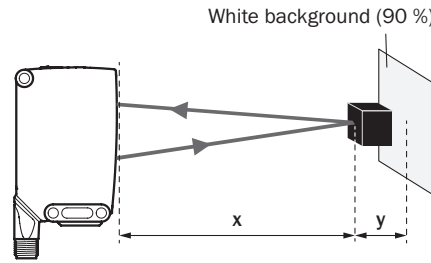

Black object (6 % remission)  
Set sensing range x = 800 mm  
Needed minimum distance to white background y = 85 mm

Recommended sensing range for the best performance

- ① Black object, 6% remission factor
- ② Gray object, 18% remission factor
- ③ White object, 90% remission factor



Light spot size WTB26I-xxxx1xx

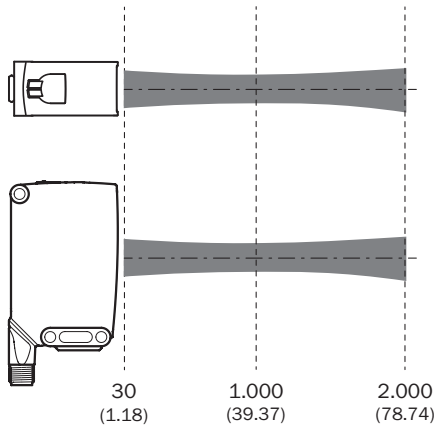
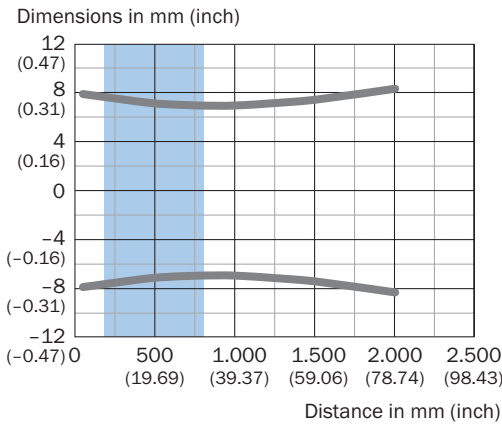

Recommended sensing range for the best performance

Sensing range diagram

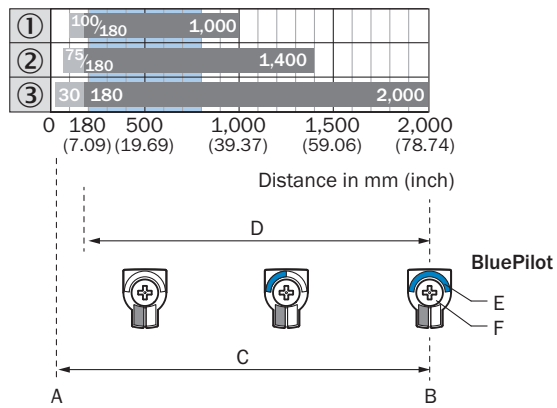









Recommended sensing range for the best performance

|   |   |
|---|---|
| 1 | Black object, 6% remission factor                         |
| 2 | Gray object, 18% remission factor                         |
| 3 | White object, 90% remission factor                        |
| A | Sensing range min. in mm                                  |
| B | Sensing range max. in mm                                  |
| C | Field of view   |
| D | Adjustable switching threshold for background suppression |
| E | Sensing range indicator                                   |
| F | Teach-Turn adjustment                                     |

Recommended accessories

Other models and accessories → [www.sick.com/W26](http://www.sick.com/W26)

|   | Brief description  | Type          | part no. |
|---|--|---------------|----------|
| Mounting systems  |  |               |          |
|    | <ul style="list-style-type: none"> <li><b>Description:</b> Mounting bracket with hinged arm</li> <li><b>Material:</b> Steel</li> <li><b>Details:</b> Steel, zinc coated</li> <li><b>Items supplied:</b> Mounting hardware included</li> <li><b>Suitable for:</b> W23-2, W27-3, Reflex Array</li> </ul>   | BEF-WN-W27    | 2009122  |
|    | <ul style="list-style-type: none"> <li><b>Description:</b> Plate N12 for universal clamp. For mounting PL30A, P250 reflectors, W27 and WTR2 sensors.</li> <li><b>Material:</b> Steel, zinc diecast</li> <li><b>Details:</b> Zinc plated steel (sheet), Zinc die cast (clamping bracket)</li> <li><b>Items supplied:</b> Universal clamp (2022726), mounting hardware</li> <li><b>Usable for:</b> W26, Reflex Array, P250, W23-2, W27-3, W27-3</li> </ul> | BEF-KHS-N12   | 2071950  |
|   | <ul style="list-style-type: none"> <li><b>Description:</b> Mounting bracket with articulated arm</li> <li><b>Material:</b> Steel</li> <li><b>Details:</b> Steel, zinc coated</li> <li><b>Items supplied:</b> Mounting hardware included</li> <li><b>Suitable for:</b> W16, W26, W11, W12, W23, W27, Dx50, W280, G10</li> </ul>   | BEF-WN-MULTI2 | 2093945  |
|  | <ul style="list-style-type: none"> <li><b>Description:</b> Mounting bracket</li> <li><b>Material:</b> Steel</li> <li><b>Details:</b> Steel, zinc coated</li> <li><b>Items supplied:</b> Mounting hardware included</li> <li><b>Suitable for:</b> W23-2, W27-3, Reflex Array</li> </ul>   | BEF-WN-W23    | 2019085  |
|  | <ul style="list-style-type: none"> <li><b>Description:</b> Plate N11N for universal clamp bracket</li> <li><b>Material:</b> Stainless steel</li> <li><b>Details:</b> Stainless steel 1.4571 (sheet), Stainless steel 1.4408 (clamp)</li> <li><b>Items supplied:</b> Universal clamp (5322627), mounting hardware</li> <li><b>Usable for:</b> DeltaPac, Glare, WTD20E</li> </ul>  | BEF-KHS-N11N  | 2071081  |

|   | Brief description  | Type               | part no. |
|---|--|--------------------|----------|
| connectors and cables   |  |                    |          |
|  | <ul style="list-style-type: none"> <li>• <b>Connection type head A:</b> Male connector, M12, 4-pin, straight, A-coded</li> <li>• <b>Description:</b> Unshielded</li> <li>• <b>Connection systems:</b> Screw-type terminals</li> <li>• <b>Permitted cross-section:</b> ≤ 0.75 mm<sup>2</sup></li> </ul>   | STE-1204-G         | 6009932  |
|  | <ul style="list-style-type: none"> <li>• <b>Connection type head A:</b> Female connector, M12, 4-pin, straight, A-coded</li> <li>• <b>Connection type head B:</b> Flying leads</li> <li>• <b>Signal type:</b> Sensor/actuator cable</li> <li>• <b>Cable:</b> 5 m, 4-wire, PVC</li> <li>• <b>Description:</b> Sensor/actuator cable, unshielded</li> <li>• <b>Application:</b> Zones with chemicals, Uncontaminated zones</li> </ul>  | YF2A14-050VB3XLEAX | 2096235  |
|  | <ul style="list-style-type: none"> <li>• <b>Connection type head A:</b> Female connector, M12, 4-pin, straight, A-coded</li> <li>• <b>Connection type head B:</b> Flying leads</li> <li>• <b>Signal type:</b> Sensor/actuator cable</li> <li>• <b>Cable:</b> 5 m, 4-wire, PUR, halogen-free</li> <li>• <b>Description:</b> Sensor/actuator cable, unshielded</li> <li>• <b>Application:</b> Uncontaminated zones, Zones with oils and lubricants, Robot, Drag chain operation</li> </ul> | YF2A14-050UB3XLEAX | 2095608  |



## SICK AT A GLANCE

SICK is one of the leading manufacturers of intelligent sensors and sensor solutions for industrial applications. A unique range of products and services creates the perfect basis for controlling processes securely and efficiently, protecting individuals from accidents and preventing damage to the environment.

We have extensive experience in a wide range of industries and understand their processes and requirements. With intelligent sensors, we can deliver exactly what our customers need. In application centers in Europe, Asia and North America, system solutions are tested and optimized in accordance with customer specifications. All this makes us a reliable supplier and development partner.

Comprehensive services complete our offering: SICK LifeTime Services provide support throughout the machine life cycle and ensure safety and productivity.

For us, that is “Sensor Intelligence.”

### WORLDWIDE PRESENCE:

Contacts and other locations – [www.sick.com](http://www.sick.com)

SpareCruX