

IMB30-20NNOVU2S

IMB

INDUCTIVE PROXIMITY SENSORS

SICK
Sensor Intelligence.

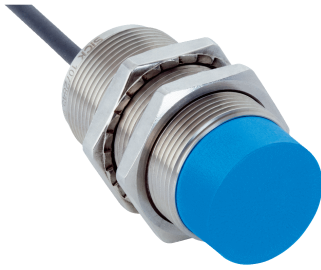

Ordering information

Type	part no.
IMB30-20NNOVU2S	1072848

Included in delivery: BEF-MU-M30N (1)

Other models and accessories → www.sick.com/IMB

Illustration may differ

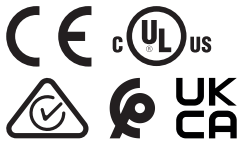

Detailed technical data

Features

Housing	Metric
Housing	Standard design
Thread size	M30 x 1.5
Diameter	Ø 30 mm
Sensing range S_n	20 mm
Safe sensing range S_a	16.2 mm
Installation type	Non-flush
Switching frequency	500 Hz
Connection type	Cable, 3-wire, 2 m
Switching output	NPN
Switching output detail	NPN
Output function	NC
Electrical wiring	DC 3-wire
Enclosure rating	IP68 ¹⁾ IP69K ²⁾
Special features	Resistant against coolant lubricants, Visual adjustment indicator, Temperature resistance
Special applications	Zones with coolants and lubricants, Mobile machines, Difficult application conditions
Items supplied	Mounting nut, V2A stainless steel, with locking teeth (2x)

¹⁾ According to EN 60529.

²⁾ According to ISO 20653:2013-03.

Mechanics/electronics

Supply voltage	10 V DC ... 30 V DC
-----------------------	---------------------

¹⁾ At I_a max.

²⁾ Supply voltage U_B and constant ambient temperature T_a .

³⁾ Of S_r .

⁴⁾ When using the non-toothed side of the nut.

⁵⁾ Valid if toothed side of nut is used.

Ripple	≤ 10 %
Voltage drop	≤ 2 V ¹⁾
Hysteresis	3 % ... 20 %
Reproducibility	≤ 2 % ²⁾ ³⁾
Temperature drift (of S_r)	± 10 %
EMC	According to EN 60947-5-2
Continuous current I_a	≤ 200 mA
No load current	≤ 10 mA
Cable material	PUR
Conductor size	0.34 mm ²
Cable diameter	Ø 4.5 mm
Short-circuit protection	✓
Power-up pulse protection	✓
Shock and vibration resistance	100 g / 2 ms / 500 cycles; 150 g / 1 Mio cycles; 10 Hz ... 55 Hz / 1 mm; 55 Hz ... 500 Hz / 60 g
Ambient operating temperature	-40 °C ... +100 °C
Housing material	Stainless steel V2A, DIN 1.4305 / AISI 303
Sensing face material	Plastic, LCP
Housing length	60 mm
Thread length	44 mm
Tightening torque, max.	Typ. 100 Nm ⁴⁾ Typ. 100 Nm ⁵⁾
Protection class	III
UL File No.	E181493

¹⁾ At I_a max.

²⁾ Supply voltage U_B and constant ambient temperature T_a.

³⁾ Of S_r.

⁴⁾ When using the non-toothed side of the nut.

⁵⁾ Valid if toothed side of nut is used.

Safety-related parameters

MTTF_D	1,971 years
DC_{avg}	0 %

Reduction factors

Note	The values are reference values which may vary
St37 steel (Fe)	1
Stainless steel (V2A, 304)	Approx. 0.78
Aluminum (Al)	Approx. 0.44
Copper (Cu)	Approx. 0.36
Brass (Br)	Approx. 0.46

Installation note

Remark	Associated graphic see "Installation"
---------------	---------------------------------------

A	20 mm
B	62 mm
C	30 mm
D	60 mm
E	20 mm
F	160 mm

Certificates

EU declaration of conformity	✓
UK declaration of conformity	✓
ACMA declaration of conformity	✓
Moroccan declaration of conformity	✓
China RoHS	✓
cULus certificate	✓

Classifications

ECLASS 5.0	27270101
ECLASS 5.1.4	27270101
ECLASS 6.0	27270101
ECLASS 6.2	27270101
ECLASS 7.0	27270101
ECLASS 8.0	27270101
ECLASS 8.1	27270101
ECLASS 9.0	27270101
ECLASS 10.0	27270101
ECLASS 11.0	27270101
ECLASS 12.0	27274001
ETIM 5.0	EC002714
ETIM 6.0	EC002714
ETIM 7.0	EC002714
ETIM 8.0	EC002714
UNSPSC 16.0901	39122230

Installation note Non-flush installation



Connection diagram Cd-003

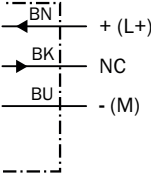

Response diagram

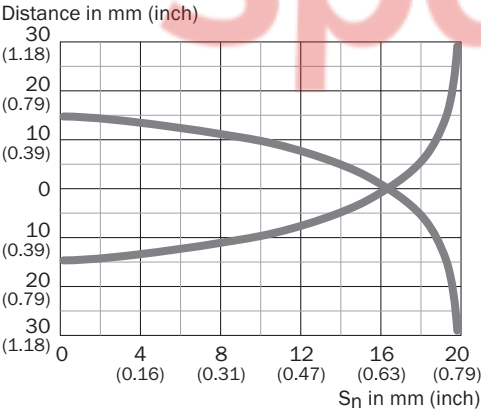

Functional principle Installation aid

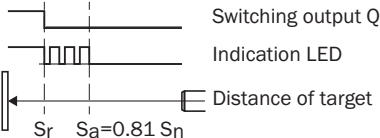

Dimensional drawing IMB30 Standard, cable, non-flush

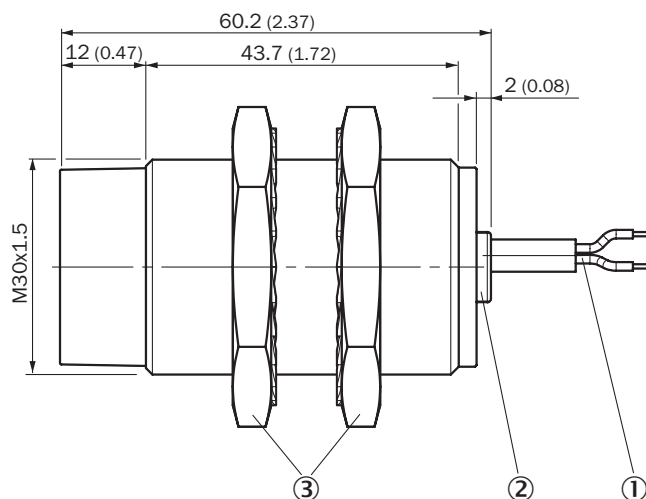





Dimensions in mm (inch)

- ① Connection
- ② Display LED
- ③ Fastening nuts (2 x); width across 36, stainless steel V2A

Recommended accessories

Other models and accessories → www.sick.com/IMB

	Brief description	Type	part no.
Mounting systems			
	<ul style="list-style-type: none"> • Description: Mounting bracket for M30 sensors • Material: Steel • Details: Steel, zinc coated • Items supplied: Without mounting hardware 	BEF-WN-M30	5308445
	<ul style="list-style-type: none"> • Description: Mounting plate for M30 sensors • Material: Steel • Details: Steel, zinc coated • Items supplied: Without mounting hardware 	BEF-WG-M30	5321871

	Brief description	Type	part no.
connectors and cables			
	<ul style="list-style-type: none"> • Connection type head A: Female connector, M12, 4-pin, straight, A-coded • Description: Unshielded • Connection systems: Screw-type terminals • Permitted cross-section: ≤ 0.75 mm² • Application: Hygienic and washdown zones 	DOS-1204-GN	6028357
	<ul style="list-style-type: none"> • Connection type head A: Female connector, M12, 4-pin, angled, A-coded • Description: Unshielded • Connection systems: Screw-type terminals • Permitted cross-section: ≤ 0.75 mm² • Application: Hygienic and washdown zones 	DOS-1204-WN	6028358
	<ul style="list-style-type: none"> • Connection type head A: Male connector, M12, 4-pin, straight, A-coded • Description: Unshielded • Connection systems: Screw-type terminals • Permitted cross-section: ≤ 0.75 mm² • Application: Hygienic and washdown zones 	STE-1204-GN	6028359

SpareCruX

SICK AT A GLANCE

SICK is one of the leading manufacturers of intelligent sensors and sensor solutions for industrial applications. A unique range of products and services creates the perfect basis for controlling processes securely and efficiently, protecting individuals from accidents and preventing damage to the environment.

We have extensive experience in a wide range of industries and understand their processes and requirements. With intelligent sensors, we can deliver exactly what our customers need. In application centers in Europe, Asia and North America, system solutions are tested and optimized in accordance with customer specifications. All this makes us a reliable supplier and development partner.

Comprehensive services complete our offering: SICK LifeTime Services provide support throughout the machine life cycle and ensure safety and productivity.

For us, that is “Sensor Intelligence.”

WORLDWIDE PRESENCE:

Contacts and other locations – www.sick.com

SpareCruX