



GRSE18S-P1336

GR18

PHOTOELECTRIC SENSORS

SICK
Sensor Intelligence.



Illustration may differ



Ordering information

| Type | part no. |
|---------------|----------|
| GRSE18S-P1336 | 1059545 |

Other models and accessories → www.sick.com/GR18

Detailed technical data

Features

| | |
|--|---|
| Functional principle | Through-beam photoelectric sensor |
| Dimensions (W x H x D) | 18 mm x 18 mm x 38.1 mm |
| Housing design (light emission) | Cylindrical |
| Thread diameter (housing) | M18 x 1 |
| Optical axis | Axial |
| Sensing range max. | 0 m ... 15 m |
| Sensing range | 0 m ... 10 m |
| Type of light | Visible red light |
| Light source | PinPoint LED ¹⁾ |
| Light spot size (distance) | Ø 250 mm (10 m) |
| Wave length | 650 nm |
| Adjustment | None |
| Display | |
| | LED green Operating indicator Static on: power on |
| | LED yellow Status of received light beam Static on: object not present Static off: object present |

¹⁾ Average service life: 100,000 h at T_U = +25 °C.

Mechanics/electronics

| | |
|---|---|
| Supply voltage U_B | 10 V DC ... 30 V DC ¹⁾ |
| Ripple | < 5 V _{pp} ²⁾ |
| Current consumption | 30 mA |
| Switching output | PNP |
| Switching mode | Light switching |
| Signal voltage PNP HIGH/LOW | V _S - (≤ 3 V) / approx. 0 V |
| Output current I_{max.} | ≤ 100 mA ³⁾ |
| Response time | < 500 μs ⁴⁾ |
| Switching frequency | 1,000 Hz ⁵⁾ |
| Connection type | Cable, 3-wire, 2 m ⁶⁾ |
| Cable material | Plastic, PVC |
| Circuit protection | A ⁷⁾ B ⁸⁾ D ⁹⁾ |
| Protection class | III |
| Housing material | Plastic, ABS |
| Optics material | Plastic, PMMA |
| Enclosure rating | IP67 |
| Items supplied | Fastening nuts (4 x) |
| Electromagnetic compatibility (EMC) | EN 60947-5-2 |
| Ambient operating temperature | -25 °C ... +55 °C ¹⁰⁾ |
| Ambient temperature, storage | -40 °C ... +70 °C |
| UL File No. | NRKH.E348498 & NRKH7.E348498 |
| Part number of individual components | 2065196 GRS18S-D1336 2065199 GRE18S-P1336 |

¹⁾ Limit values. Operated in short-circuit protected network: max. 8 A.

²⁾ May not fall below or exceed U_v tolerances.

³⁾ At U_v > 24 V or ambient temperature > 49 °C, I_A max. = 50 mA.

⁴⁾ Signal transit time with resistive load.

⁵⁾ With light/dark ratio 1:1.

⁶⁾ Do not bend below 0 °C.

⁷⁾ A = V_S connections reverse-polarity protected.

⁸⁾ B = inputs and output reverse-polarity protected.

⁹⁾ D = outputs overcurrent and short-circuit protected.

¹⁰⁾ At U_v ≤ 24V and I_A < 50mA.

Certificates

| | |
|---|---|
| EU declaration of conformity | ✓ |
| UK declaration of conformity | ✓ |
| ACMA declaration of conformity | ✓ |
| Moroccan declaration of conformity | ✓ |
| China RoHS | ✓ |
| ECOLAB certificate | ✓ |
| cULus certificate | ✓ |

| | |
|--|---|
| Photobiological safety (DIN EN 62471) certificate | ✓ |
|--|---|

Classifications

| | |
|-----------------------|----------|
| ECLASS 5.0 | 27270901 |
| ECLASS 5.1.4 | 27270901 |
| ECLASS 6.0 | 27270901 |
| ECLASS 6.2 | 27270901 |
| ECLASS 7.0 | 27270901 |
| ECLASS 8.0 | 27270901 |
| ECLASS 8.1 | 27270901 |
| ECLASS 9.0 | 27270901 |
| ECLASS 10.0 | 27270901 |
| ECLASS 11.0 | 27270901 |
| ECLASS 12.0 | 27270901 |
| ETIM 5.0 | EC002716 |
| ETIM 6.0 | EC002716 |
| ETIM 7.0 | EC002716 |
| ETIM 8.0 | EC002716 |
| UNSPSC 16.0901 | 39121528 |



Connection type

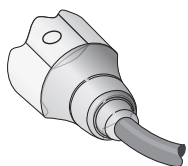

Connection diagram Cd-049

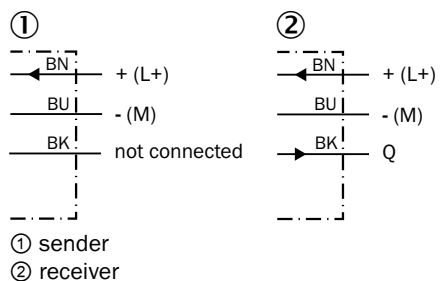

Characteristic curve GRSE18S



Light spot size GRSE18, red light

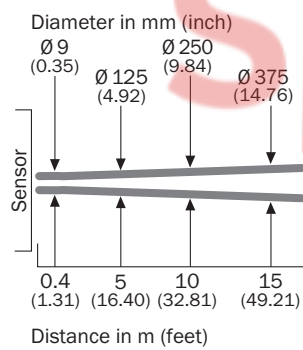

Sensing range diagram GRSE18S

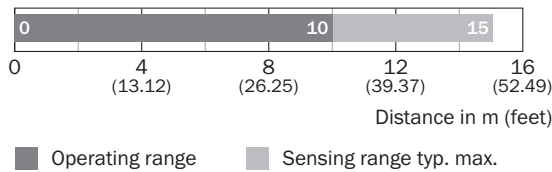

Response range GRSE18S

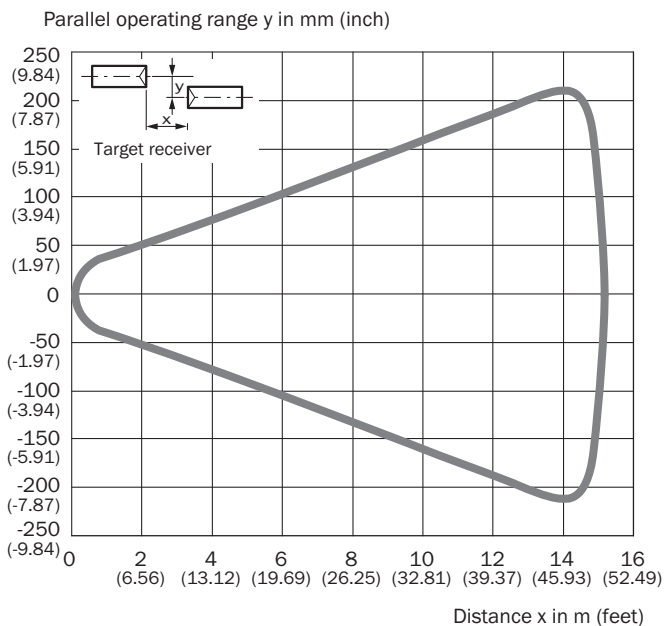

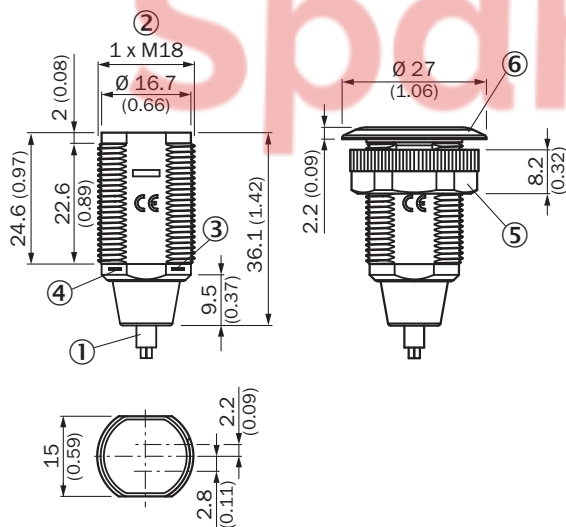

Dimensional drawing GR18S, plastic, cable, straight



Recommended accessories

Other models and accessories → www.sick.com/GR18

| | Brief description | Type | part no. |
|---|--|------------|----------|
| Mounting systems | | | |
|  | <ul style="list-style-type: none"> Description: Mounting bracket for M18 sensors Material: Steel Details: Steel, zinc coated Items supplied: Without mounting hardware Suitable for: GR18, V180-2, V18, W15, Z1, Z2 | BEF-WN-M18 | 5308446 |
| connectors and cables | | | |
|  | <ul style="list-style-type: none"> Connection type head A: Male connector, M8, 3-pin, straight, A-coded Description: Unshielded Connection systems: Screw-type terminals Permitted cross-section: 0.14 mm² ... 0.5 mm² | STE-0803-G | 6037322 |

SpareCruX

SICK AT A GLANCE

SICK is one of the leading manufacturers of intelligent sensors and sensor solutions for industrial applications. A unique range of products and services creates the perfect basis for controlling processes securely and efficiently, protecting individuals from accidents and preventing damage to the environment.

We have extensive experience in a wide range of industries and understand their processes and requirements. With intelligent sensors, we can deliver exactly what our customers need. In application centers in Europe, Asia and North America, system solutions are tested and optimized in accordance with customer specifications. All this makes us a reliable supplier and development partner.

Comprehensive services complete our offering: SICK LifeTime Services provide support throughout the machine life cycle and ensure safety and productivity.

For us, that is “Sensor Intelligence.”

WORLDWIDE PRESENCE:

Contacts and other locations – www.sick.com

SpareCruX