



SpareCruX

# GSE2S-F1311

G2

PHOTOELECTRIC SENSORS

**SICK**  
Sensor Intelligence.



Illustration may differ



### Ordering information

Type	part no.
GSE2S-F1311	1064363

Other models and accessories → [www.sick.com/G2](http://www.sick.com/G2)

### Detailed technical data

#### Features

<b>Functional principle</b>	Through-beam photoelectric sensor
<b>Dimensions (W x H x D)</b>	7.7 mm x 21.8 mm x 13.5 mm
<b>Housing design (light emission)</b>	Rectangular
<b>Sensing range max.</b>	0 m ... 2 m
<b>Sensing range</b>	0 m ... 1.5 m
<b>Type of light</b>	Visible red light
<b>Light source</b>	PinPoint LED <sup>1)</sup>
<b>Light spot size (distance)</b>	Ø 23 mm (500 mm)
<b>Wave length</b>	640 nm
<b>Adjustment</b>	None

<sup>1)</sup> Average service life: 100,000 h at T<sub>U</sub> = +25 °C.

#### Mechanics/electronics

<b>Supply voltage U<sub>B</sub></b>	10 V DC ... 30 V DC <sup>1)</sup>
<b>Ripple</b>	< 5 V <sub>pp</sub> <sup>2)</sup>
<b>Current consumption</b>	20 mA <sup>3)</sup>

<sup>1)</sup> Limit values when operated in short-circuit protected network: max. 8 A.

<sup>2)</sup> May not fall below or exceed U<sub>y</sub> tolerances.

<sup>3)</sup> Without load.

<sup>4)</sup> Signal transit time with resistive load.

<sup>5)</sup> With light/dark ratio 1:1.

<sup>6)</sup> Do not bend below 0 °C.

<sup>7)</sup> A = V<sub>S</sub> connections reverse-polarity protected.

<sup>8)</sup> C = interference suppression.

<sup>9)</sup> D = outputs overcurrent and short-circuit protected.

<b>Switching output</b>	PNP
<b>Switching mode</b>	Dark switching
<b>Output current I<sub>max</sub></b>	≤ 50 mA
<b>Response time</b>	< 0.6 ms <sup>4)</sup>
<b>Switching frequency</b>	800 Hz <sup>5)</sup>
<b>Connection type</b>	Cable, 3-wire, 2 m <sup>6)</sup>
<b>Cable material</b>	Plastic, PVC
<b>Cable diameter</b>	Ø 3 mm
<b>Circuit protection</b>	A <sup>7)</sup> C <sup>8)</sup> D <sup>9)</sup>
<b>Weight</b>	72.2 g
<b>Housing material</b>	Plastic, ABS
<b>Optics material</b>	Plastic, PMMA
<b>Enclosure rating</b>	IP67
<b>Ambient operating temperature</b>	-25 °C ... +50 °C
<b>Ambient temperature, storage</b>	-40 °C ... +75 °C
<b>UL File No.</b>	NRKH.E181493

1) Limit values when operated in short-circuit protected network: max. 8 A.

2) May not fall below or exceed U<sub>y</sub> tolerances.

3) Without load.

4) Signal transit time with resistive load.

5) With light/dark ratio 1:1.

6) Do not bend below 0 °C.

7) A = V<sub>S</sub> connections reverse-polarity protected.

8) C = interference suppression.

9) D = outputs overcurrent and short-circuit protected.

### Safety-related parameters

<b>MTTF<sub>D</sub></b>	2,659 years
<b>DC<sub>avg</sub></b>	0 %

### Certificates

<b>EU declaration of conformity</b>	✓
<b>UK declaration of conformity</b>	✓
<b>ACMA declaration of conformity</b>	✓
<b>Moroccan declaration of conformity</b>	✓
<b>China RoHS</b>	✓
<b>cULus certificate</b>	✓
<b>Photobiological safety (DIN EN 62471) certificate</b>	✓

### Classifications

<b>ECLASS 5.0</b>	27270901
<b>ECLASS 5.1.4</b>	27270901
<b>ECLASS 6.0</b>	27270901

<b>ECLASS 6.2</b>	27270901
<b>ECLASS 7.0</b>	27270901
<b>ECLASS 8.0</b>	27270901
<b>ECLASS 8.1</b>	27270901
<b>ECLASS 9.0</b>	27270901
<b>ECLASS 10.0</b>	27270901
<b>ECLASS 11.0</b>	27270901
<b>ECLASS 12.0</b>	27270901
<b>ETIM 5.0</b>	EC002716
<b>ETIM 6.0</b>	EC002716
<b>ETIM 7.0</b>	EC002716
<b>ETIM 8.0</b>	EC002716
<b>UNSPSC 16.0901</b>	39121528

Connection type

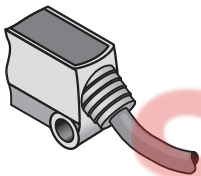

SpareCruX

Connection diagram Cd-049

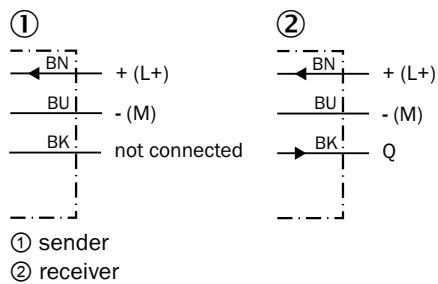

### Characteristic curve

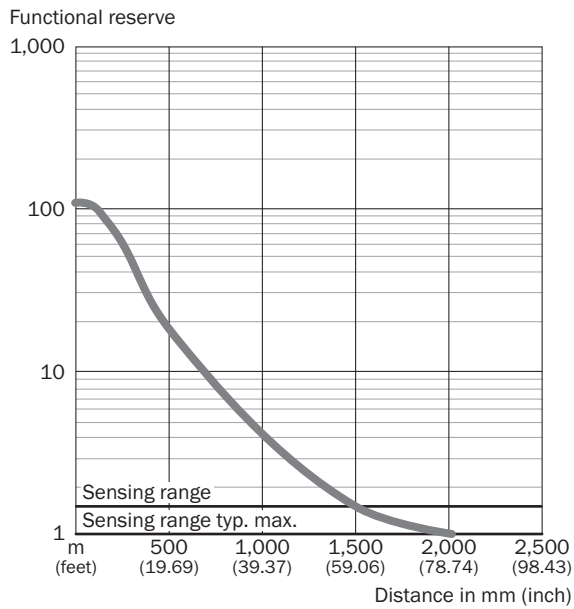

### Light spot size

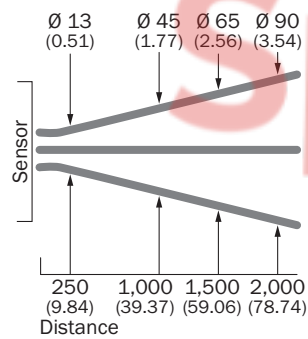

### Sensing range diagram

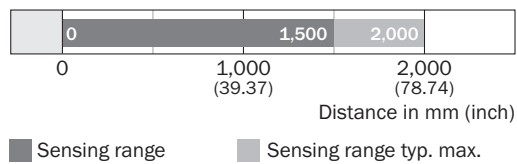

Dimensional drawing GSE2S

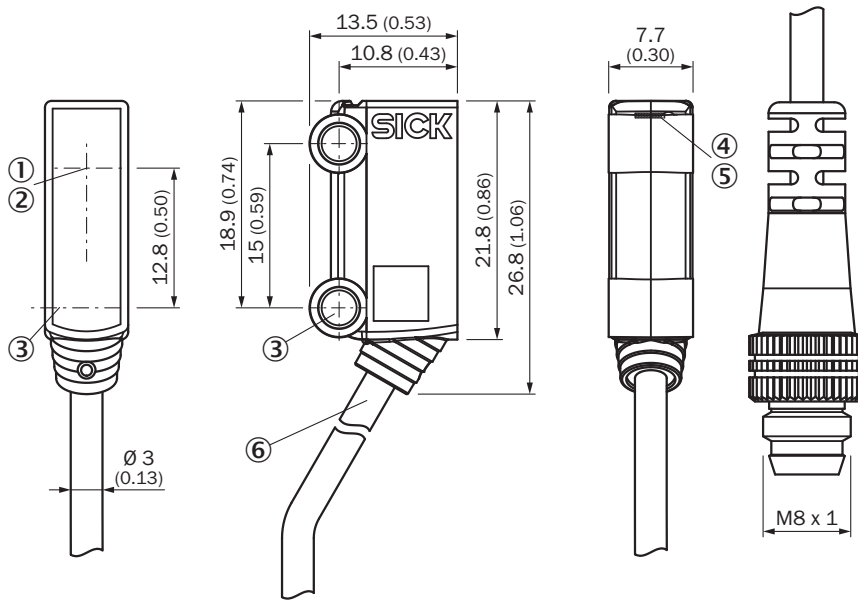



Dimensions in mm (inch)

- ① optical axis, receiver
- ② optical axis, sender
- ③ Mounting hole, Ø 3.2 mm
- ④ LED indicator green: Supply voltage active
- ⑤ LED indicator yellow: Status of received light beam
- ⑥ Connection



Recommended accessories

Other models and accessories → [www.sick.com/G2](http://www.sick.com/G2)

	Brief description	Type	part no.
Mounting systems			
	<ul style="list-style-type: none"> <li>• <b>Description:</b> Mounting bracket for floor mounting</li> <li>• <b>Material:</b> Steel</li> <li>• <b>Details:</b> Steel, zinc coated</li> <li>• <b>Items supplied:</b> Without mounting hardware</li> <li>• <b>Suitable for:</b> W2S-2</li> </ul>	BEF-W2S-A	4034748
	<ul style="list-style-type: none"> <li>• <b>Description:</b> Plate N11N for universal clamp bracket</li> <li>• <b>Material:</b> Stainless steel</li> <li>• <b>Details:</b> Stainless steel 1.4571 (sheet), Stainless steel 1.4408 (clamp)</li> <li>• <b>Items supplied:</b> Universal clamp (5322627), mounting hardware</li> <li>• <b>Usable for:</b> DeltaPac, Glare, WTD20E</li> </ul>	BEF-KHS-N11N	2071081

	Brief description	Type	part no.
connectors and cables			
	<ul style="list-style-type: none"><li>• <b>Connection type head A:</b> Male connector, M8, 3-pin, straight, A-coded</li><li>• <b>Description:</b> Unshielded</li><li>• <b>Connection systems:</b> Screw-type terminals</li><li>• <b>Permitted cross-section:</b> 0.14 mm<sup>2</sup> ... 0.5 mm<sup>2</sup></li></ul>	STE-0803-G	6037322

SpareCruX

## SICK AT A GLANCE

SICK is one of the leading manufacturers of intelligent sensors and sensor solutions for industrial applications. A unique range of products and services creates the perfect basis for controlling processes securely and efficiently, protecting individuals from accidents and preventing damage to the environment.

We have extensive experience in a wide range of industries and understand their processes and requirements. With intelligent sensors, we can deliver exactly what our customers need. In application centers in Europe, Asia and North America, system solutions are tested and optimized in accordance with customer specifications. All this makes us a reliable supplier and development partner.

Comprehensive services complete our offering: SICK LifeTime Services provide support throughout the machine life cycle and ensure safety and productivity.

For us, that is “Sensor Intelligence.”

### WORLDWIDE PRESENCE:

Contacts and other locations – [www.sick.com](http://www.sick.com)

SpareCruX